

TekExpress™ Serial ATA
Automated Compliance Solutions
Online Help

Copyright © Tektronix. All rights reserved. Licensed software products are owned by Tektronix or its subsidiaries or suppliers, and are protected by national copyright laws and international treaty provisions.

Tektronix products are covered by U.S. and foreign patents, issued and pending. Information in this publication supersedes that in all previously published material. Specifications and price change privileges reserved.

TEKTRONIX and TEK are registered trademarks of Tektronix, Inc.

TekExpress Serial ATA Online help, 076-0096-02.

Contacting Tektronix

Tektronix, Inc.
14200 SW Karl Braun Drive
P.O. Box 500
Beaverton, OR 97077
USA

For product information, sales, service, and technical support:

- In North America, call 1-800-833-9200.
- Worldwide, visit www.tektronix.com to find contacts in your area.

Table of Contents

General Safety Summary	v
Introduction	
Using Online Help	1
Related Documentation	2
Conventions	2
Technical Support	3
Getting Started	
What is new in this release	5
Accessories	6
Minimum System Requirements	7
Application Directories and Usage	8
File Name Extensions	9
How To Activate the License	10
Before You Click Run	12
Operating Basics	
TekExpress Application Overview	15
Key Features	15
Starting the Application	16
Resizing the Application Window	17
Exiting the Application	17
Global Controls	18
Menus	
File Menu	19
View Menu	20
Tools Menu	21
Help Menu	24

How To

Select the Test(s).....	25
Configure and Run the Test(s).....	28
View and Select Connected Instruments	31
Use Prerecorded Waveforms for Analysis	33
View the Progress of Analysis	37
View the Report.....	39
View Test Related Files	40

Application Examples

RSG-RMT Suite

Testing a Drive

RSG-RMT Equipment Setup: Drive.....	41
RSG-01 - Gen1 (1.5Gb/s) Receiver Signalling Group.....	43
RMT- Receiver Margin Test	46

Testing a Host

RSG-RMT Equipment Setup: Host	49
RSG-02 - Gen2 (3.0Gb/s) Receiver Signalling Group.....	51
RMT- Receiver Margin Test	55

PHY-TSG-OOB Suite

Testing a Drive

PHY-TSG-OOB Equipment Setup: Drive	58
PHY01 - Unit Interval-Gen1 Test.....	59
TSG02 - Rise-Fall Time-Gen1 Test without RF Switch.....	63
OOB01 - OOB Signal Detection Threshold-Gen1 Test.....	67

Testing a Host

PHY-TSG-OOB Equipment Setup:Host	71
TSG03 - Differential Skew-Gen 2 Test.....	72
OOB06 - COMWAKE Gap Detection Windows Test	76

Rx-Tx Suite

Testing a Drive

Rx-Tx Equipment Setup: Drive	80
Rx01 - Pair Differential Impedance test.....	81
Tx02 - Single-Ended Impedance test	85

Testing a Host

Rx-Tx Equipment Setup: Host	89
Rx03 - Differential Mode Return Loss	90

SI Cable test

SI Equipment Setup	94
SI-02 - Cable Absolute Differential Impedance test on a SATA Cable	95

Deskew Operation

Deskewing Real Time Oscilloscopes	99
Manual Deskew Procedure for Sampling Oscilloscopes	100
Mixed Mode TDR Channel Alignment with Independent TDR Source	100
Sampling Oscilloscope Deskew during RXTX Testing for Test Setup without RF Switch	105

Overriding Acquire Parameters

About Overriding Acquire Parameters	107
Acquire parameters with “Automatically” option	107
Acquire Parameters with “Manually” Option	109

Pattern Generation Utility

Using the Pattern Generation Utility to Test Receivers	111
Calibration Procedure	114

User Configuration for TekExpress SATA

Setting User Option for SATA DUT Power Cycle Method	119
---	-----

Calibration and Verification of Jitter Measurement Devices

About JTF Calibration and Verification	123
Basic Procedure	124
Detailed Procedure	125

AWG Calibration Procedure for OOB tests

OOB-01 Level Calibration Procedure using DPOJET Application	133
OOB-01 Calibration Procedure without using the DPOJET Application	138

TekExpress Programmatic Interface

About the Programmatic Interface	141
Server and Client Proxy Objects	143
Remote Proxy Object	143
Client Proxy Object	144
Programmatic Interface APIs	
Connect()	146
Disconnect()	147
LockSession()	148
UnlockSession()	149
SetTimeOut()	150
GetTimeOut()	152
GetDutId()	153
ChangeDutId()	154
SaveSession()	155

SaveSessionAs()	156
RecallSession().....	157
Run()	158
Stop().....	159
QueryStatus().....	160
TransferReport()	161
CheckSessionSaved()	162
ApplicationStatus()	163
ErrorCodes	164
Example	165

Troubleshooting

Instrument Connectivity	167
User Interface	167
TestStand Run time Engine Installation.....	168
Test Limit is Single Sided	169
Report shows as NAN.....	170

Reference

Instrument Connectivity using GPIB Cable	171
Shortcut Keys	171
Error Codes for TekExpress	173

Index

General Safety Summary

Review the following safety precautions to avoid injury and prevent damage to this product or any products connected to it.

To avoid potential hazards, use this product only as specified.

Only qualified personnel should perform service procedures.

While using this product, you may need to access other parts of a larger system. Read the safety sections of the other component manuals for warnings and cautions related to operating the system.

To Avoid Fire or Personal Injury

Connect and Disconnect Properly. Connect the probe output to the measurement instrument before connecting the probe to the circuit under test. Connect the probe reference lead to the circuit under test before connecting the probe input. Disconnect the probe input and the probe reference lead from the circuit under test before disconnecting the probe from the measurement instrument.

Observe All Terminal Ratings. To avoid fire or shock hazard, observe all ratings and markings on the product. Consult the product manual for further ratings information before making connections to the product.

Do Not Operate Without Covers. Do not operate this product with covers or panels removed.

Do Not Operate With Suspected Failures. If you suspect that there is damage to this product, have it inspected by qualified service personnel.

Avoid Exposed Circuitry. Do not touch exposed connections and components when power is present.

Terms in this Manual

These terms may appear in this manual:



WARNING. *Warning statements identify conditions or practices that could result in injury or loss of life.*



CAUTION. *Caution statements identify conditions or practices that could result in damage to this product or other property.*

Using Online Help

Select Help from the menu to open the help file. You can also find an electronic copy of the help file in the Documents directory on the 063-4068-XX DVD.

Tables of Contents (TOC) tab — Organizes the Help into book-like sections. Select a book icon to open a section; select any of the topics listed under the book.

Index tab — Enables you to scroll a list of alphabetical keywords. Select the topic of interest to bring up the appropriate help page.

Search tab — Allows a text-based search.

Follow these steps:

1. Type the word or phrase you want to find in the search box. If the word or phrase is not found, try the Index tab.
2. Choose a topic in the lower box, and then select the Display button.

General Help Functions:

- Select the Print button from the Help topics menu bar to print a topic.
- To return to the previous window, select the Back button.
- Use hyperlinks to jump from one topic to another.
- If the back button is grayed out or a jump is not available, choose the Help Topics button to return to the originating help folder.

Related Documentation

In addition to this TekExpress Online Help, the following documentation is included with the software:

- *TekExpress Installation Manual*, Tektronix part number 077-0143-XX. The Installation Manual has information about installing and upgrading the software.
- *TekExpress Quick Start User Manual*, Tektronix part number 077-0142-XX. The Quick Start User Manual has information about how to use the software and includes application examples.

Technical Specification documents



http://www.tek.com/Measurement/applications/serial_data/sata.html

Conventions

Online Help uses the following conventions:

- The term “SATA” refers to Serial Advanced Technology Attachment.
- The term “DUT” is an abbreviation for Device Under Test.
- The term “select” is a generic term that applies to the two mechanical methods of choosing an option: using a mouse or using the touch screen.

Table 1: Icon descriptions

Icon	Meaning
	This icon identifies important information.
	This icon identifies conditions or practices that could result in loss of data.
	This icon identifies additional information that will help you use the application more efficiently.

Technical Support

Tektronix values your feedback on our products. To help us serve you better, please send us your suggestions, ideas, or comments on your application or oscilloscope.

When you contact Tektronix Technical Support, please include the following information (be as specific as possible):

General Information

- All instrument model numbers.
- Hardware options, if any.
- Probes used.
- Your name, company, mailing address, phone number, FAX number.
- Please indicate if you would like to be contacted by Tektronix about your suggestion or comments.

Application Specific Information

- Software version number.
- Description of the problem such that technical support can duplicate the problem.
- If possible, save the setup files for all the instruments used and the application.
- If possible, save the TekExpress setup files, log.xml and status messages text file.
- If possible, save the waveform on which you are performing the measurement as a .wfm file.

Forward the information to technical support using one of these methods:

- E-mail – techsupport@tektronix.com
- FAX – (503) 627-5695

What is new in this release

This version of TekExpress Serial ATA includes the following feature enhancements:

- Supports UTD 1.3 version for all the SATA test suites.
- Improved test execution time.

The previous releases of TekExpress had the following feature enhancements:

- The Programmatic interface which allows you to seamlessly integrate the TekExpress Test Automation application with the high-level automation layer.
- The PHY-TSG-OOB test suite is included for Serial ATA Gen1 and Gen2 test coverage which offers compliance test automation solution for PHY General requirements (PHY: 1-4), PHY Transmitted Signal Group Requirements (TSG: 1-12), PHY OOB Requirements (OOB: 1-7) using a Tektronix Real Time DSO.
- The Rx-Tx test suite is included for Serial ATA Gen1 and Gen2 test coverage which offers compliance test automation solution for PHY Transmit (TX: 1-6) and PHY Receive (RX: 1-6) channel test requirements using Tektronix sampling oscilloscope.
- The SI test suite is included for SATA electrical cable assembly compliance testing using a sampling oscilloscope with IConnect-S-parameter and impedance profile computational software.
- Also includes RSG-RMT test suite for Serial ATA Gen1 and Gen2 test coverage which offers Phy Receiver Signal Group Requirements (RSG 1-2) and Receiver Margin Test (RMT) which were part of earlier version of TekExpress Serial ATA.

Accessories

About the Test Fixture

The TF-SATA-NE-ZP and TF-SATA-FE-ZP test fixtures that facilitate SATA Compliance testing are manufactured and distributed by Crescent Heart Software, Inc. For more information, visit the Crescent Heart Software Web site www.c-h-s.com.

About Frame Error Analyzer

The Crescent Heart Software SATA II probe adapter facilitates Receiver Signalling Group test. Visit www.c-h-s.com for more information.

About Keithley Switch

The S46 Microwave Switch System is designed to simplify the automated switching needed to test a wide range of telecommunications products and devices. For more information, visit <http://www.keithley.com/applications/aerospace/?mn=S46>.

About the Power Splitter

The power splitter part number 1580 Divider PWR DC-26.5 GHz is required in certain test configurations of TekExpress SATA (RSG-RMT, RXTX without RF switch). For more information, visit the Aeroflex/Weinschel Inc Web site www.aeroflex-weinschel.com.

Minimum System Requirements

The minimum system requirements for a PC to run TekExpress are as follows:

Table 2: System requirements

Processor	Pentium 4/M or equivalent processor.
Operating System	Windows XP Service Pack 2.
Memory	512 MB of memory.
Hard Disk	Approximately 2 GB of available hard-disk space for the recommended installation, which includes full TekExpress installation and distributed components.
Drive	DVD drive
Display	Super VGA resolution or higher video adapter (800x600 minimum video resolution for small fonts or 1024x768 minimum video resolution for large fonts). The application is best viewed in 96 dpi display settings ¹ .
Software	<ul style="list-style-type: none"> ■ IConnect® and MeasureXtractor™ Signal Integrity TDR and S-parameter Software (80SICON) Ver 4.0 or above. ■ Microsoft Excel 2002 or above. ■ Microsoft Internet Explorer 6.0 SP1 or later. ■ Microsoft Photo Editor 3.0 or equivalent software for image files viewing. ■ Adobe Reader 6.0 or equivalent software for viewing portable document format (PDF) files.
Other Devices	<ul style="list-style-type: none"> ■ Microsoft compatible mouse or compatible pointing device. ■ Four USB ports (2 USB ports minimum). ■ PCI-GPIB or equivalent interface for instrument connectivity ².

¹ If TekExpress is running on an instrument having a video resolution lower than 800x600 (for example, sampling oscilloscope), it is recommended to connect a secondary monitor and this has to be enabled before launching the application.

² If TekExpress is installed on a Tektronix oscilloscope, the virtual GPIB port cannot be used by TekExpress for communicating with oscilloscope applications. If external devices like USB-GPIB or equivalent are used for instrument connectivity, then ensure that the Talker Listener utility is enabled in DPO/DSA oscilloscope's GPIB menu.

Application Directories and Usage

Related Topics

[File Name Extensions](#)

[How To Activate the License](#)

[View Test Related Files](#)

The application directory and associated files are organized as follows:

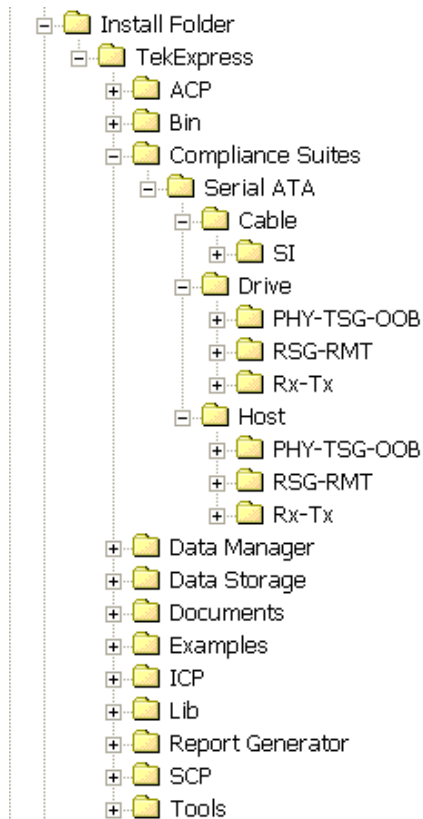

The following table lists the default directory names and their usage:

Table 3: Default directory names and their usage

Directory names	Usage
InstallDir\TekExpress	Contains the application and associated files.
\TekExpress\Compliance Suites	Has compliance specific sequence files. The folders under this directory represent the devices to be tested.
\TekExpress\Compliance Suites\Serial ATA\	The folders under this are Cable, Drive and Host.
\TekExpress\Compliance Suites\Serial ATA\Cable	Includes the SI folder. This represents the suite of install tests for SATA cables.
\TekExpress\Compliance Suites\Serial ATA\Drive\ \TekExpress\Compliance Suites\Serial ATA\Host\	Includes the PHY-TSG-OOB, RSG-RMT, and RX-TX folders. These represent the suites of install tests for the SATA drive and host devices.

Table 3: Default directory names and their usage (cont.)

Directory names	Usage
\TekExpress\ACP \TekExpress\SCP \TekExpress\ICP	Includes instrument and application specific interface libraries of TekExpress.
\TekExpress\Data Manager \TekExpress\Data Storage \TekExpress\Report Generator	Includes the result management specific libraries of TekExpress are present in these folders.
\TekExpress\Documents	Includes the Method of Implementation documents and technical documentation for the application.
\TekExpress\Bin \TekExpress\Lib \TekExpress\Tools	Includes the Miscellaneous libraries of TekExpress.

File Name Extensions

Related Topics

[Application Directories and Usage](#)

[How To Activate the License](#)

The software uses the following file name extensions:

File name extension	Description
.TekX	The session file will be saved in this format.
.seq	The test sequence file.
.xml	The encrypted XML file that contains the test specific configuration information. The log file extension is also xml.
.PDF	The PDF file that details the method of implementation for the test.

How To Activate the License

Related Topics
[Application Directories and Usage](#)
[File Name Extensions](#)

Follow the steps below to activate the license:

1. Click **Help > About** to view the license information.



2. Click the **View Version Details** link to check the version numbers of the installed test suites.

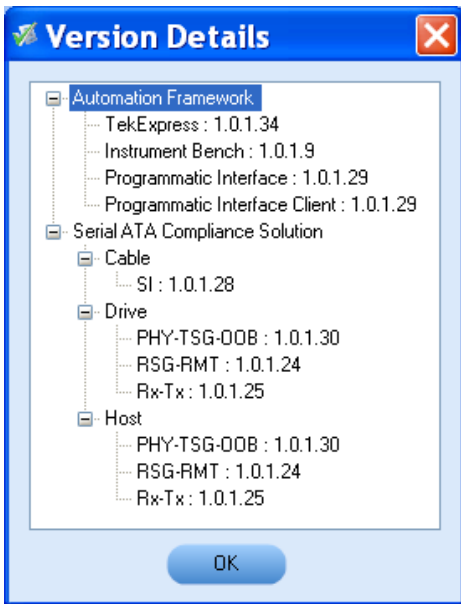

3. Click the **View End-User License Agreement** link to open the following Tektronix Software License Agreement window. Click **Print** to print the License Agreement.

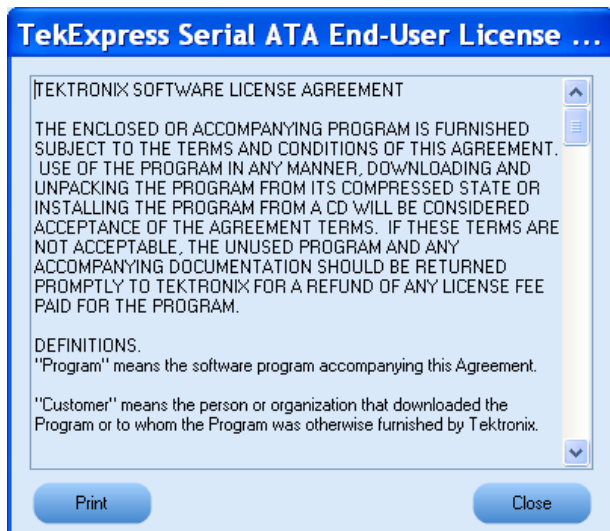

4. Click **License Info** to view the available software options. This window shows the license key and the various options with their status (active or inactive) with the current license key.
5. If you are activating the license for the first time, the license key field will be empty. To activate the license, connect the USB dongle to your computer, enter the license key provided in the license key certificate, and click **Activate**. If the activation is successful, a  sign is displayed next to the license key field.

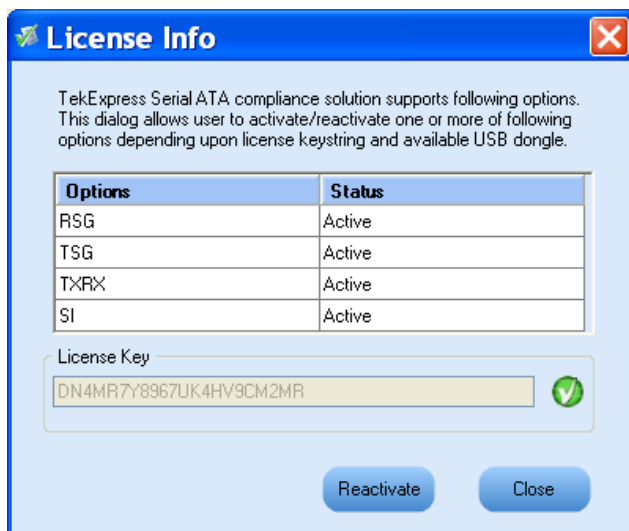

6. If you are reactivating the license, click **Reactivate**, enter the new license key and click **Activate**.

Before You Click Run

After you first launch TekExpress, it creates the following folders on your computer:

- \My Documents\My TekExpress

NOTE. Ensure that the “My TekExpress” folder has read and write access.

NOTE. If a user with a different Windows login ID launches TekExpress, a new My TekExpress folder is created under that user’s My Documents folder

- \My Documents\My TekExpress\Serial ATA
- \My Documents\My TekExpress\Serial ATA\Untitled Session. Every time the TekExpress SATA.exe is launched a Untitled Session folder is created under Serial ATA folder. The Untitled Session folder is deleted when you exit TekExpress.



CAUTION. Each session has multiple files associated with it. Do not modify any of the session files and/or folders as this may result in loss of data or corrupted session files.

- The My TekExpress folder is created as a shared folder with share name as <domain><user ID> My TekExpress (or if the PC is not connected to domain then share name is <Computer name><user ID> My TekExpress).
- The above shared folder is mapped as X: (X drive) on to the PC where TekExpress is running.

NOTE. If X drive is mapped to any other shared folder, TekExpress will display a Warning message window asking to disconnect the X: drive manually.

Do the following before you click Run:

NOTE. Ensure that the network connectivity is enabled on the PC running the TekExpress.

1. [Map](#) the shared My TekExpress folder as X: (X drive) on all the instruments used in test setup running Microsoft Windows Operating System. This share folder is used to save the waveform files or any other file transfer operations.
2. Right click on the My TekExpress folder and open the **Properties** dialog box. Select **General** tab and then **Advanced**. In the **Advanced Attributes** window, ensure that the option **Encrypt contents to secure data** is NOT selected. Click [here](#) to view the picture.

3. Ensure that the SATA setup files provided with TekExpress DVD are available on the respective instruments. For more details, refer to the `ReadmeFirst.txt` located in the `SATA Setup Files` folder on the TekExpress DVD.
4. Ensure that all the required instruments are properly warmed up, [Signal Path Compensation \(SPC\)](#) is performed, followed by cable deskew.

Mapping My TekExpress folder

To map the My TekExpress folder on the instruments, follow the steps below:

1. Open Windows Explorer.
2. From the Windows Explorer menu, select **Tools > Map Network drive**.
3. Select the Drive letter as X: (if there is any previous connection on X:, disconnect it first through **Tools > Disconnect Network drive** menu of Windows Explorer).
4. In the Folder field, enter remote My TekExpress folder path (for example, \\192.158.97.65\John's My TekExpress)
5. You can determine the IP address of the PC where "My TekExpress" folder exists by doing the following:
 - Select **Start > Run** menu on the PC where My TekExpress folder exists.
 - Enter `cmd` and click **Enter**.
 - At command prompt, type `ipconfig`.

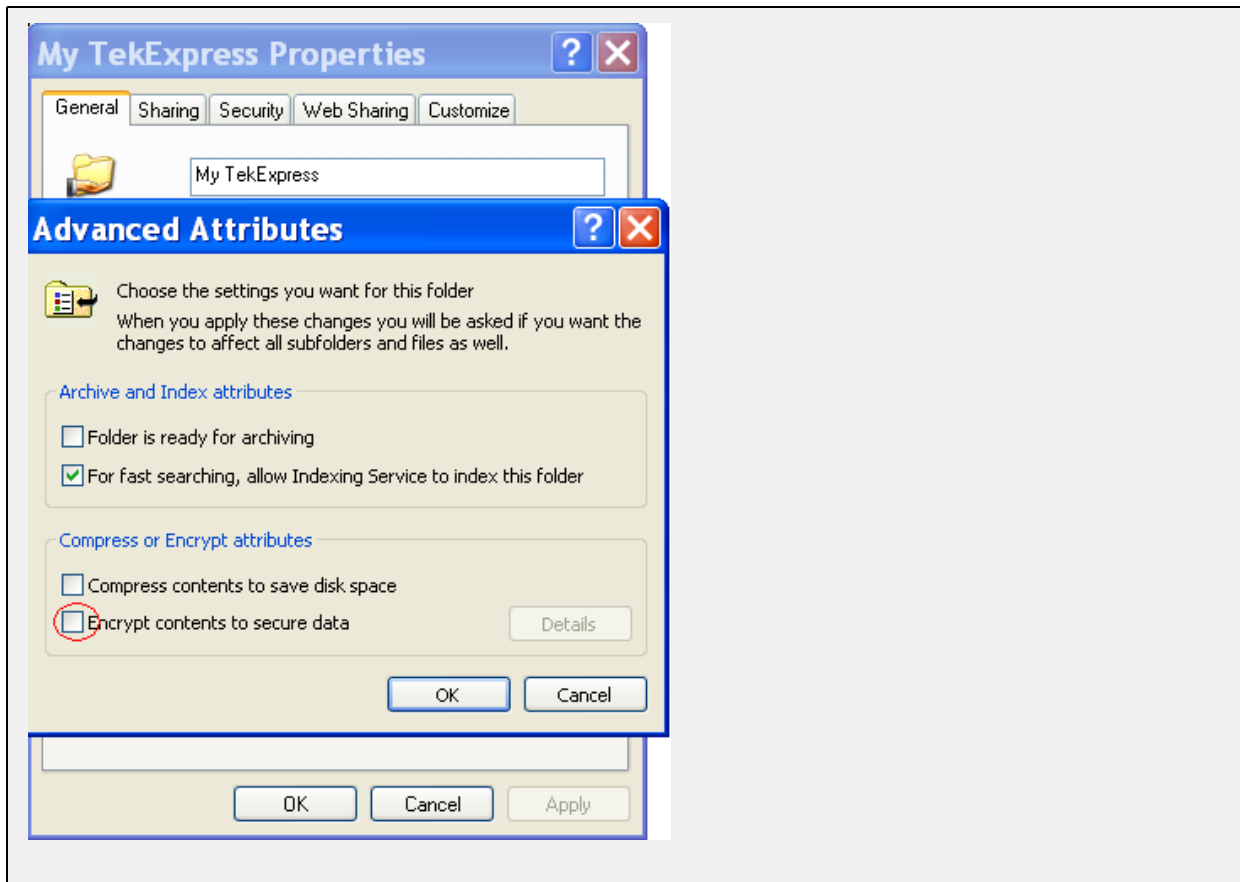

You can find SPC by following the steps below:

1. On the oscilloscope main menu, click **Utilities** menu.
2. Click **Instrument Calibration** option.

TekExpress Application Overview

TekExpress is the Tektronix Compliance Test Automation Framework, developed to support current and future test automation needs of customers. Developed using National Instruments' TestStand, TekExpress leverages on the capabilities of Microsoft .NET framework. It is a highly modular architecture that enables deploying automated test solutions for various serial standards in a relatively short time. TekExpress provides a compliance test automation solution for the Serial ATA Gen 1 and Gen 2 standard.

Options available with TekExpress Serial ATA are:

- PHY/TSG/OOB Test Suite – The PHY-TSG-OOB test suite is included for Serial ATA Gen1 and Gen2 test.
- RSG-RMT Test Suite – Offers Phy Receiver Signal Requirements (RSG 1-2) and Receiver Margin Test (RMT).
- Rx-Tx Test Suite – The RX-TX test suite is included for Serial ATA Gen1 and Gen2 test.
- TekExpress SATA Bundle for the Host and Drive Test Suites.
- SI Cable Tests for TekExpress SATA – The SI test suite is included for SATA electrical cable assembly compliance test.

Key Features

The TekExpress provides the following salient features:

- Complete SATA Gen1 and Gen2 Test Coverage for Hosts, Drives and Cables.
- Completely automated single button solution.
- Significant Reduction In Testing Time Through Automation.
- Performs all (UTD 1.2 and UTD 1.3 conformant) SATA MOI required Transmitter, Receiver and Channel measurements.
- Single & Simple Microsoft Windows XP User Interface for Multi-instrument Testing.
- Repeatable and Accurate Results.
- Automatic HTML Report and SATA-IO (MS Excel) Scorecard Generation.
- Receiver Margin Testing.
- Direct Synthesis and Device State Control Eliminates the Need for Multiple Sources.
- Powered by NI TestStand™.
- Seamlessly Integrate with High-level TestStand Automation Layer.

Starting the Application

Related Topics

[Resizing the Application Window](#)

[Exiting the Application](#)

The application uses a USB dongle that contains the license key. This dongle must be present on the PC or the instrument hosting the TekExpress application.

The application also checks for a file, called `Resources.xml`, located in My TekExpress folder. If this file is not found, instrument discovery is performed before launching TekExpress. The `Resources.xml` file contains information regarding instruments available on network.

When the application starts, it checks for the appropriate license key. If the valid license key is not present, the application switches to the “Demo” mode. If the application fails to detect the dongle, it continues to run in Demo mode.

To start the application, you can do one of the following:

- Click **Start > Programs > Tektronix > TekExpress > TekExpress SATA**. Other applications follow similar pattern.
- Double click the icon  on the desktop.
- If you have previously saved a session, you can double-click the session file stored under My TekExpress\Serial ATA.

When the application is launched it displays the splash screen providing launch information. The application also checks for the presence and validity of the USB dongle.







NOTE. If the application was not terminated properly during the last use, a dialog box asks to recall the previously unsaved session.

Resizing the Application Window

Related Topics

[Starting the Application](#)

[Exiting the Application](#)

- To minimize the application, click  on the application title bar. To restore the application to its previous size, select  in the Windows task bar.
- To maximize the application, click . To restore it to previous size, click  on the application title bar.

Exiting the Application

Related Topics

[Starting the Application](#)

[Resizing the Application Window](#)

To exit the application, do one of the following:

- Click **File > Exit**.
- Click  on the application title bar.

Global Controls

The menus and controls that appear outside the individual tabs are called “Global Controls”. These are used to specify the devices to be tested.

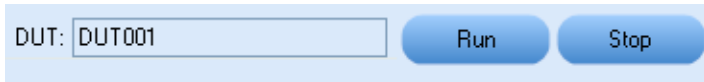



Table 4: Controls and Functions

Control name	Function
DUT	The device ID is specified at the global level and the information is stored in the default location for all data files. This field cannot be empty and does not allow these special characters (.,,.,.,.,.,\,/:?"<> *). The maximum length of characters allowed is 32.
	You will be able to run, pause, resume and stop the tests.

File Menu

Related Topics

[View Menu](#)

[Tools Menu](#)

[Help Menu](#)

Click **File** on the application menu bar.

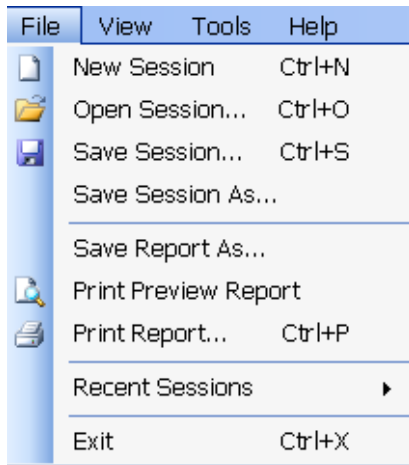

The File menu has the following selections:

Menu	Function
New Session	Starts a default session of TekExpress.
Open Session	Opens a saved session.
Save Session	Saves the session.
Save Session As	Saves a session in a different name.
Save Report As	Saves the report in user specified location.
Print Preview Report	Previews the report before printing.
Print Report	Opens the Windows "Print" dialog box.
Recent Sessions	Lists recent sessions.
Exit	Closes the application.

View Menu

Related Topics

[File Menu](#)[Tools Menu](#)[Help Menu](#)

Click **View** on the application menu bar.

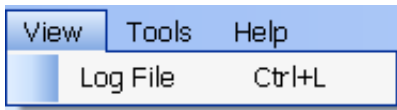

The View menu has the following selections:

Menu	Function
Log File	Opens the log (log.xml) file in the default viewer.

Tools Menu

Related Topics

- [File Menu](#)
- [View Menu](#)
- [Help Menu](#)
- [Deskewing Real Time Oscilloscopes](#)

Click **Tools** on the application menu bar.

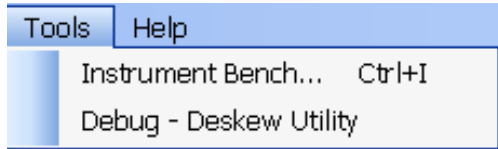

The Tools menu has the following selections:

Menu	Function
Instrument Bench	Opens a dialog box showing the list of instruments attached to the test setup.
Debug – Deskew Utility	Opens a control panel that allows to control the RF-switch for debugging and cable deskew.

Tools > Instrument Bench

The Instrument Bench window shows the list of VISA and Non-VISA resources found on different interfaces/connections. It serves two purposes at the launch of TekExpress:

- Discovers the connected instruments.
- Confirms the instrument connection setup.

When you click **Tools > Instrument Bench**, the following dialog box is displayed:

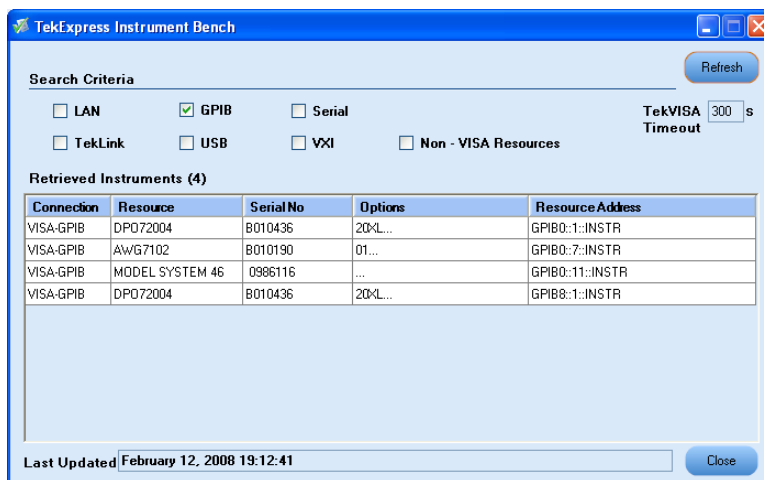

- **Search Criteria:** The various connections on which you can search. **Non-VISA Resources** are the instruments that cannot be searched using TekVISA.
- **Retrieved Instruments:** Displays the count and details of instruments that were discovered.
- **Last Updated:** Displays the time when the last time search was performed.
- **TekVISA Refresh Timeout (Seconds):** This time out specifies the maximum time that TekExpress can wait for TekVISA update.

NOTE. TekExpress uses TekVISA for instrument search. Ensure that TekVISA is running on your system before you refresh the instrument bench window.

Table 5: Retrieved Resources properties in the Instrument Bench window

Title	Description
Connection	Shows the type of connection with the instrument.
Resource	Shows the name of the resource.
Serial Number	Shows the serial number of the resource.
Options	Shows the options available on the instrument. ¹
Resource Address	Shows IP Address/Port number of the resource.

¹ The option column displays the options that fit in the field. To view complete options on the instrument, move the mouse cursor over the option.

Table 6: Button controls on Instrument Bench dialog box

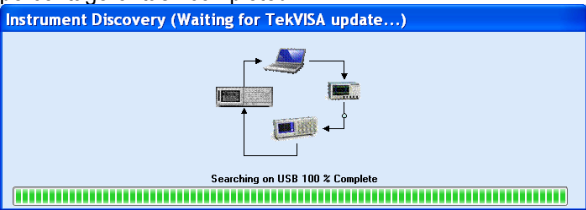
Button	Function
Refresh	The application searches on the selected connection for resources. While searching resources it shows the Instrument Bench discovery window. The Discovery window shows the connection currently being scanned and the percentage of task completed.
	
Close	Closes the dialog box.

Tools > Debug-Deskew Utility

The debug-deskew utility allows you to control the RF-switch state for setup debug purpose with primary objective to perform a real-time oscilloscope [deskew](#) operation for complex wiring path from the DUT TX terminals to the oscilloscope channels through the RF-switch. Using this utility, you can set the oscilloscope deskew values that will be retained by TekExpress SATA automation script throughout various testing suites.

To ensure accurate results for two-channel measurements and differential signals acquired on two channels, it is important to first deskew the oscilloscope channels before you take measurements of your DUT.

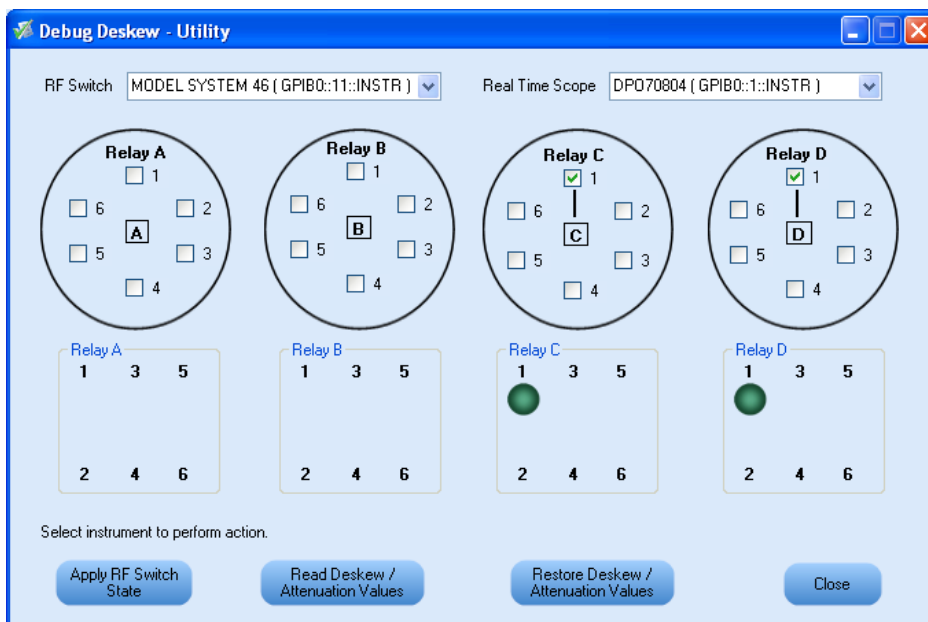



The Debug Deskew Utility has the following functions:

- **Apply RF Switch State:** Sets the Open/Close state of the RF switch channels.

As per the setup requirement, select the channels on the panel to be closed or opened. The previous state of the RF switch will be overridden by the new state. The current state of the RF Switch is not recalled when the Debug panel is launched. Click  and the current state as seen on the panel will be applied on the selected RF Switch. The selection shown by LEDs on the RF Switch should be same as the selection shown on the panel.

- **Read Deskew/Attenuation Values:** Reads the current Deskew values of the real time oscilloscope.

With the selected switch state, you are expected to manually perform the deskew (by removing SMA cable connection from TX terminals of CHS fixture at DUT and reconnecting them to Fast-edge output of the oscilloscope). Once the deskew values are set on the oscilloscope, click . The deskew values of all the four channels on the selected real time oscilloscope is read by TekExpress and are retained during test automation sequencing.

- **Restore Deskew/Attenuation values:** Click  to restore the last values of deskew/attenuation. It will be restored to the selected oscilloscope.

NOTE. The address of the instruments are passed to the panel on the current suite selection (as detected in instrument discovery). For example, in RX-TX and SI test suites, the Real Time Oscilloscope is not available and so it will not be passed. Only the address of the RF Switch is passed, if detected.

For more information on how to deskew real time oscilloscopes, refer to the section [Deskew operation](#).

Help Menu

Related Topics

[File Menu](#)

[View Menu](#)

[Tools Menu](#)

Click **Help** on the application menu bar.

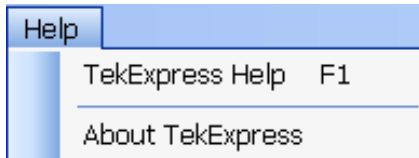

The Help menu has the following selections:

Selection	Description or Function
TekExpress Help	Displays TekExpress Help (F1).
About TekExpress	Displays application details such as software name, version number and copyright.

Select the Test(s)

Related Topics

- [View and Select Connected Instruments](#)
- [Configure and Run the Tests](#)
- [View the Progress of Analysis](#)
- [View the Report](#)
- [View Test Related Files](#)

The application tests three types of SATA devices for compliance.

- Cable
- Drive
- Host

The Select panel allows you to select tests to configure and run.

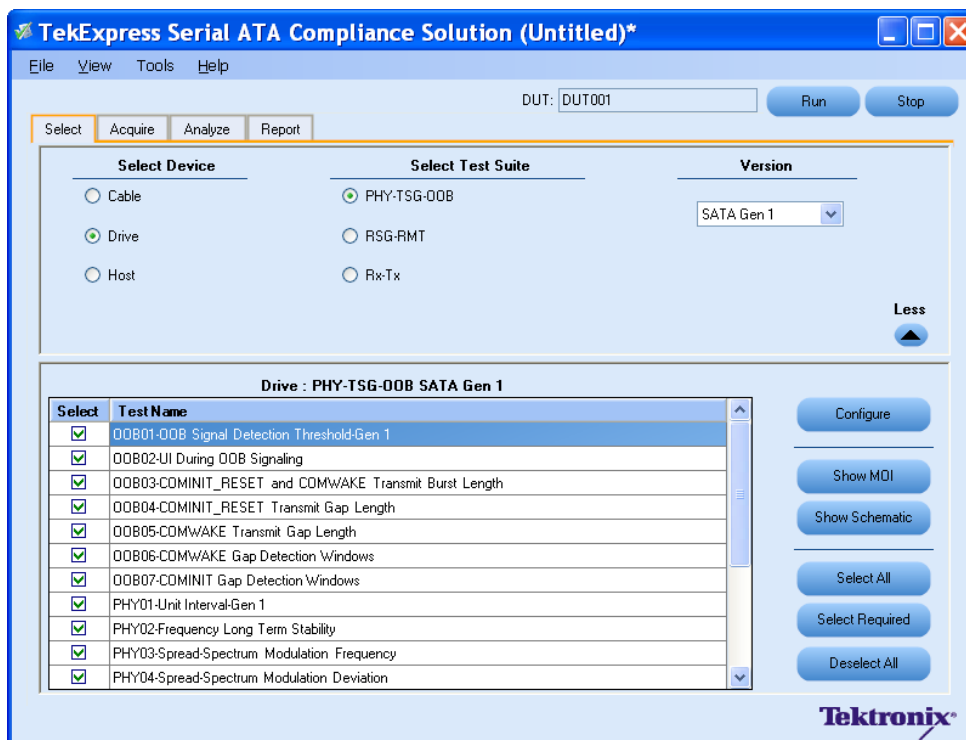

This panel provides the following functions:

Select Device

Select the Device type. And the test suite options will be automatically updated corresponding to the device selected.

Select Test Suite

The application allows you to select a subset of tests to execute. Based on the test suite selected, the Version drop-down list will be populated.

Version

You can select the appropriate version. For example, SATA Gen 1 or SATA Gen 2.

NOTE. *The SI test suite for cable measurement does not have any versions.*

More/Less

The table has the following two columns:

- **Select:** You can include or exclude any test for analysis.
- **Test Name:** Displays the name of the test.

NOTE. *If any of the check box in the Select column is grayed, you cannot make any changes. It implies that the test is mandatory.*

Once you select a row, the following options are available:

Table 7: Button controls on the Select panel







Button	Description
	Opens the configuration panel for the selected test.
	Opens the PDF of method of implementation (MOI) for the selected test.
	Opens the schematic for the selected test. This is useful if you want to verify the test setup before running the test.
	Selects all tests in the table.
	Selects all the SATA-IO required tests in the grid and deselects all informative tests in the table.

Table 7: Button controls on the Select panel (cont.)

Button	Description
 A blue rectangular button with rounded corners and a slight gradient, containing the text "Deselect All" in white.	Deselects all tests in the table.

Configure and Run the Test(s)

Related Topics

- [Select the Tests](#)
- [View and Select Connected Instruments](#)
- [View the Progress of Analysis](#)
- [View the Report](#)
- [View Test Related Files](#)

The configuration panel is used to create, view, and edit the parameters associated with the acquisition and the analysis of the selected test.

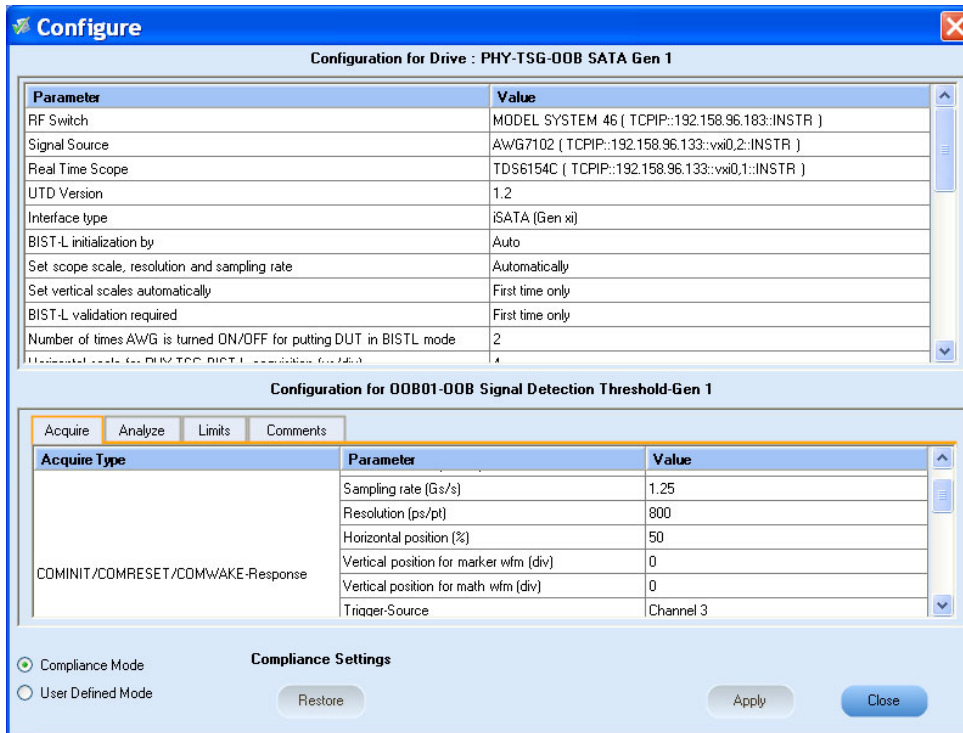

You have the following options:

- To choose between running the tests in a Compliance or User Defined mode.
- To reload compliance mode values.
- To change the parameters associated with the configuration of acquisition.
- To change the parameters associated with analysis configuration.
- To change the test limits in User Defined mode.

The upper half of the Configure panel has general parameters that are common for all the tests under the selected test suite that are editable. The lower half of the Configure panel has test specific parameters.

NOTE. If any of the test parameters are grayed, it means that these parameters cannot be modified in compliance mode. When you switch to user-defined mode, these parameters are editable.

Table 8: Test parameters

Parameters to configure

Acquire Parameters

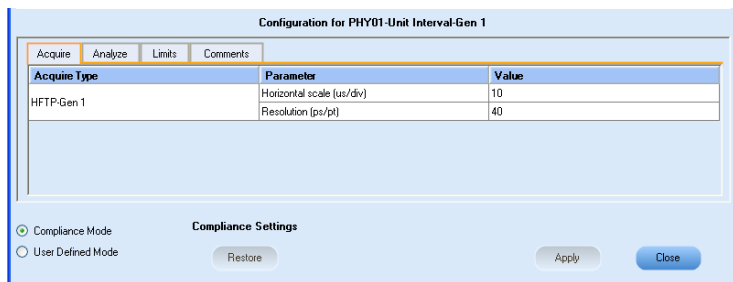

Description

Shows the various parameters related to acquisition of a selected test. These parameters can vary from one test to another such as, Number of Samples and Record Length.

Analyze parameters

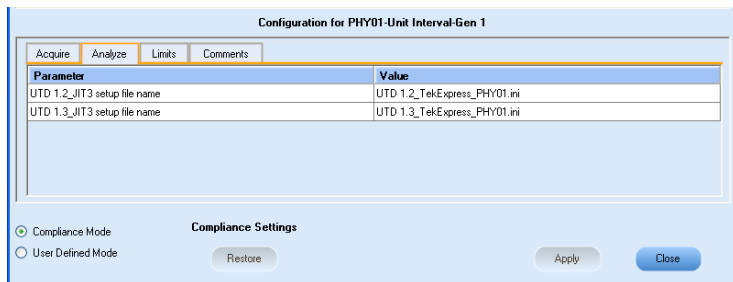

Shows the various parameters related to analysis of a selected test. The Analyze parameters shows example of Jitter values, whereas the link points out JIT3 setup files.

Limits

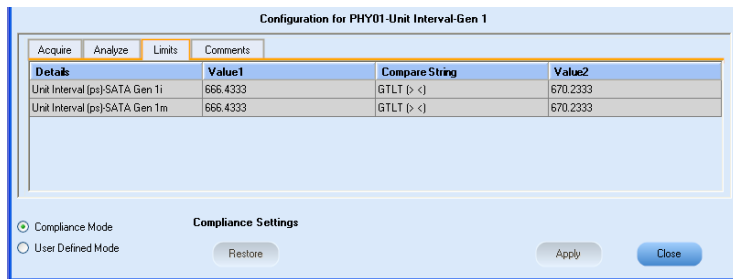

Applies to a specific test. It shows the measurement limits using different types of comparisons.

Table 8: Test parameters (cont.)

Parameters to configure

Description

Comments

You can specify a comment up to 256 characters long for the selected test.

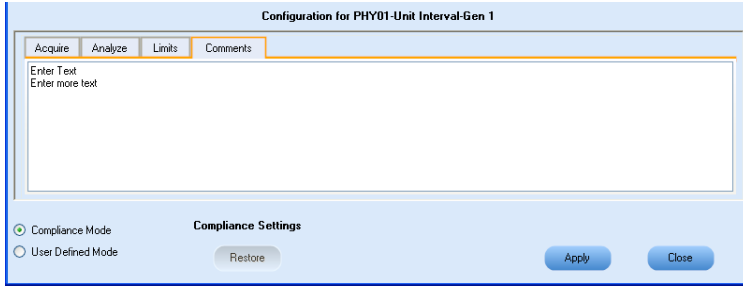

Compliance settings



The compliance settings will be restored.



Accepts all changes that you made.



Dismisses the dialog box and does not apply changes.

Click **Run** in the Select panel to run the selected tests.

Refer to the following table for different test limit comparisons:

Table 9: Different test limit comparisons

Comparison string	Description
EQ(==)	Equal to
NE(!=)	Not equal to
GT(>)	Greater than
LT(<)	Less than
GE(>=)	Greater than or Equal to
LE(<=)	Less than or Equal to
GTLT(><)	Greater than and Less than
GELT(>=<)	Greater than or equal to and Less than
GTLE(><=)	Greater than and Less or equal to
LTGT(<>)	Less than and Greater than
LEGE(<= >=)	Less than or equal to and Greater than or equal to
LEGT(<= >)	Less than or equal to and Greater than
LTGE(< >=)	Less than and Greater than or equal to
GELE(>= =<)	Greater than or equal to and Less than or equal to

View and Select Connected Instruments

Related Topics

- [Select the Tests](#)
- [Configure and Run the Tests](#)
- [View Test Related Files](#)
- [View the Progress of Analysis](#)
- [View the Report](#)

Viewing Connected Instruments

The **Tools > Instrument Bench** menu item is used to discover connected instruments required for the tests. The application uses TekVISA to discover the connected instruments. Once the operation is done, the Instrument Bench dialog box resumes operation and lists the instrument-related details based on the selected search criteria.

NOTE. When the TekVISA Instrument Manager checks for connected instruments, the Instrument Bench dialog box does not respond.

For example, if you select LAN as the search criteria in the Instrument Bench dialog and click Refresh, the TekVISA Instrument Manager checks for the instruments availability over LAN and the details of the instrument are displayed under **Retrieved Instruments** table.

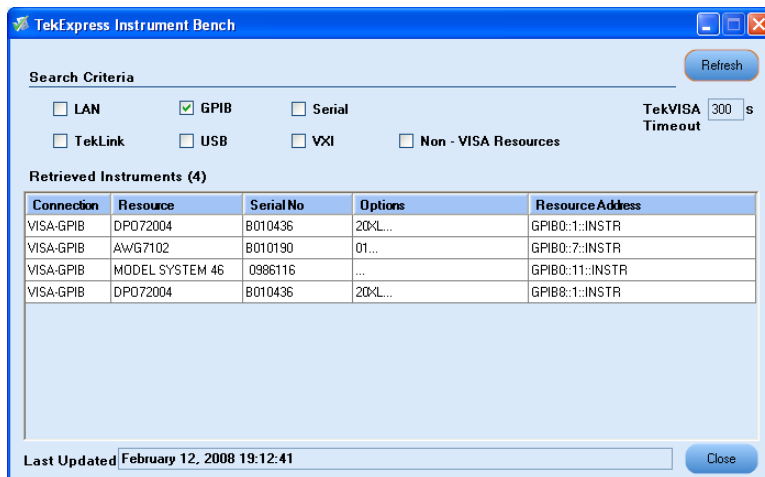

You can provide the time in the **TekVISA Refresh Timeout (Seconds)** field, within which if the TekVISA Instrument Manager does not find the instruments, the TekExpress application resumes the operation.

If you choose Non-VISA resources, all the instruments supported by TekExpress but not communicating over the VISA layer can be searched.

Selecting Connected Instruments

You can view the instruments connected in the Configuration panel. The upper half of the panel displays the general parameters for the tests under the selected test suite.

You can choose the instruments from the drop-down list as shown in the following figure:

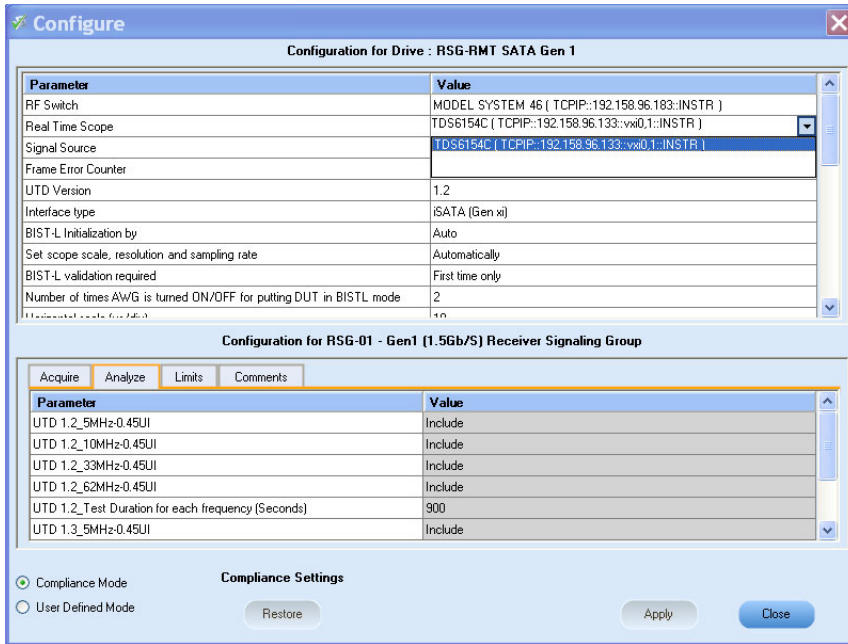

You can select the “Do Not Use” option in the drop down list for those instruments which are optional.

NOTE. The list of instruments displayed is specific to the selected test suite. It does not show all the connected instruments.

Use Prerecorded Waveforms for Analysis

From the Acquire tab, you can see unique acquisitions, acquisition parameters, acquisition status, and pre-recorded waveform files of the selected test suite. The Acquire panel is specific to a suite and gets updated every time the selected test suite is changed. This panel shows the acquisition details for the tests in the currently selected suite. The tests with the common acquisition parameters are grouped together and shown as a single acquisition.

NOTE. The acquire panel is disabled when the RSG-RMT test suite is selected. If you want to enable or disable “Use Pre Recorded Waveform files”, select a test suite other than RSG-RMT to enable the acquire panel.

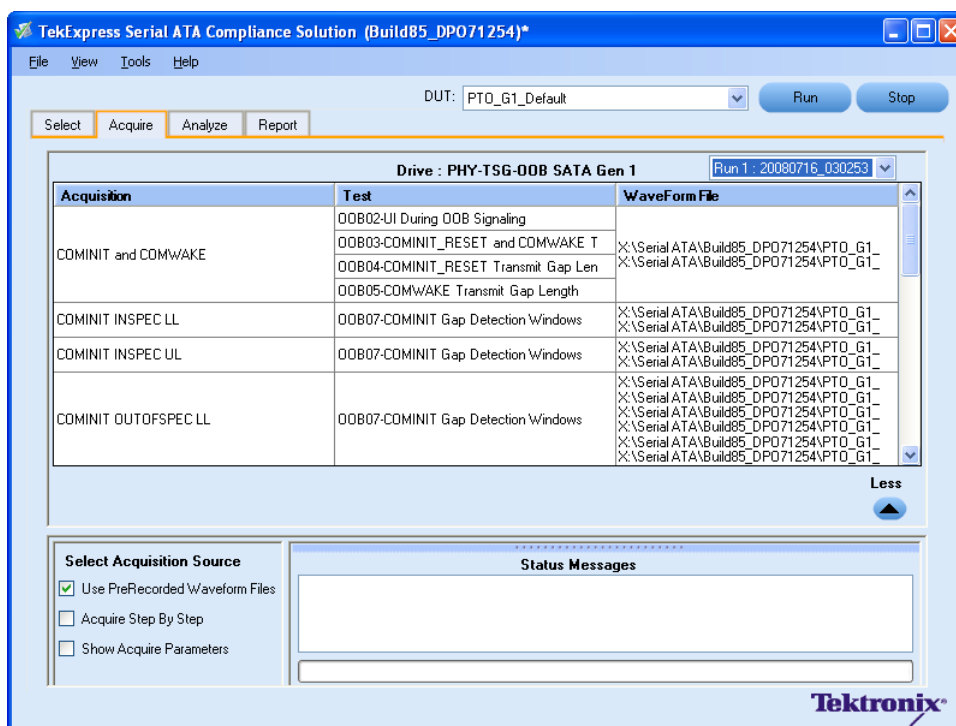

Column name	Function
Acquisition	Acquisition Name
Test	Name of the tests performing acquisitions. One or more test can perform the same acquisitions.
Status	Test acquisition status of the running test passed at intervals.
Waveform File(s)	Pre-recorded waveform files of unique acquisitions. You can select waveform files by selecting browse <input type="button" value="..."/> on individual cells. This allows you to select any waveform file using the standard file open window.

The following Acquire source options are available:

- **Use PreRecorded Waveform files:** Enabling or disabling the option shows or hides the waveform file column in the acquisition table.

When you save a session and then select this option, the DUT ID text box changes to a drop-down list, in which you can select the DUT ID up to the point where the session was saved. A drop-down box appears above the Waveform file column, showing the run details, including the date and time of each run. If you select a run, corresponding data for that run will be populated (such as the selected test, the test configuration settings, and the test summary status).

- **Acquire Step by Step:** Selecting this prompts you at the end of each acquisition before proceeding to the next one.
- **Show Acquire Parameters:** On enabling this option, the acquisition parameters for each unique acquisition is displayed in the acquisition table.
- **More/Less:** Allows you to show/hide advance panel.

When you select “Use PreRecorded Waveform Files”, the first column shows the waveform type and the second column shows the tests that use that waveform type for analysis. The following guidelines help you determine the correct prerecorded waveform for each test to be performed.

TIP. Select "Show Acquire Parameters" to verify the acquire parameters that are specified and the corresponding waveform.

Click the following links to get details on them:

Guidelines for PHY-TSG-OOB test suite waveforms

Each test requires a differential or single-ended waveform. For example, as shown in the following figure, the Unit Interval measurement requires differential waveforms, and the Rise-fall time measurement requires single-ended waveforms. Some combinations require both single-ended and differential waveforms. You need to specify all required waveforms. The waveform file name must contain on the following keywords: Diff, Pos, or Neg so that TekExpress can identify which waveforms are Differential (Diff), which are Single-Ended Positive (Pos), and which are Single-Ended Negative (Neg).

Acquisition	Test	Horizontal scale (ns/div)	Resolution (ps/div)	WaveFormFile
HFTP-Gen 1	PHY01:Unit Interval-Gen 1	10	40	X:\Serial ATA\SA72004\FD\DUT001\20080102_041145\HFTP_G1_Drive_10_40_2w2_Diff.wfm
	TSG02:Rise-Fall Time-Gen 1			X:\Serial ATA\SA72004\FD\DUT001\20080102_041145\HFTP_G1_Drive_10_40_2w2_CH2_Pos.wfm
				X:\Serial ATA\SA72004\FD\DUT001\20080102_041145\HFTP_G1_Drive_10_40_2w2_CH1_Neg.wfm

Guidelines for RXTX test suite waveforms

Test suites such as RXTX and SI need to have reference waveforms and waveforms with DUT. The acquire panel allows you to specify only DUT waveforms. The reference waveforms are stored in the following folder location:

Reference Waveforms

Location: X:\Serial ATA\Sampling Scope\TxRxScopeOperation

Naming Convention: Ref_<Acquire Type>_<Parameter1>_<Parameter2>_<Parameter3>_<Parameter4>_<Parameter5>_<Channel Pattern>.wfm

Example:

1. Ref_MFTP-TDR Common_4000_300_4e-011_1e-011_Even_CH3+CH4.wfm
2. Ref_MFTP-TDR Differential_4000_300_4e-011_1e-011_Even_CH3-CH4.wfm
3. Ref_MFTP-TDR Single Ended_4000_300_4e-011_1e-011_Even_CH3.wfm
4. Ref_TDR Common_4000_300_4e-011_1e-011_Even_CH1+CH2.wfm
5. Ref_TDR Differential_4000_300_4e-011_1e-011_Even_CH1-CH2.wfm
6. Ref_TDR Single Ended_4000_300_4e-011_1e-011_Even_CH1.wfm

DUT waveforms

DUT waveforms need to be specified in TekExpress Acquire panel as described above. The file naming convention should be as follows:

Naming Convention: <Acquire Type> <Channel Pattern>

Acquire type and corresponding channel pattern:

Acquire type	Channel pattern
TDR Differential	CH1-CH2
TDR Single Ended	CH1& CH2
TDR Common	CH1+ CH2
MFTP - TDR Differential	CH3-CH4
MFTP - TDR Single Ended	CH3, CH4
MFTP - TDR Common	CH3+CH4

Examples:

TDR Differential_CH1-CH2_EUT.wfm

TDR Single Ended_CH1.wfm

User1_TDR Common_CH1+CH2.wfm

MFTP - TDR Differential_CH3-Ch4_Session1.wfm

MFTP - TDR Single Ended_CH4_Jan31.wfm

MFTP - TDR Common_CH3+Ch4.wfm

Guidelines for SI test suite waveforms

As mentioned in the guidelines for RXTX test suite, the SI test suite also needs to have reference waveforms and waveforms with DUT. The acquire panel allows you to specify only DUT waveforms. The reference waveforms are stored in the following folder location:

Reference Waveforms

Location: X:\Serial ATA\Sampling Scope\SIScopeOperation

Naming Convention:

Ref/Ref_NoFixture_<Acquire Type>_<Parameter1>_<Parameter2>_<Parameter3>_<Parameter4>_<Parameter5>_<Parameter6>_<Parameter7>_<Parameter_8>_<Channel Pattern>.wfm

Example: Reference without fixture

Ref_NoFixture_TDR Differential_Odd_4000_128_5e-010_7e-011_5.5e-011_80_20_CH1-CH2.wfm

Ref_NoFixture_TDR Single Ended_Even_4000_128_5e-010_7e-011_5.5e-011_80_20_CH1.wfm

Ref_NoFixture_TDT CrossTalk_Odd_4000_128_3e-009_CH3-CH4.wfm

Ref_NoFixture_TDT Differential_Odd_4000_128_3e-009_CH5-CH6.wfm

Ref_NoFixture_TDR Common_Even_4000_128_5e-010_7e-011_5.5e-011_80_20_CH3+CH4.wfm

Example: Reference with fixture

Ref_TDR Common_Even_4000_128_5e-010_7e-011_5.5e-011_80_20_CH1+CH2.wfm

Ref_TDR Differential_Odd_4000_128_5e-010_7e-011_5.5e-011_80_20_CH1-CH2.wfm

Ref_TDR Single Ended_Even_4000_128_5e-010_7e-011_5.5e-011_80_20_CH4.wfm

DUT waveforms

DUT waveforms need to be specified in the TekExpress acquire panel. The file naming convention should be as follows:

Naming Convention: <Acquire Type>_<Channel Pattern>

Acquire type and corresponding channel pattern:

Acquire type	Channel pattern
TDR Differential	CH1-CH2, CH3-CH4, CH5-CH6, CH7-CH8
TDR Single Ended	CH1, CH2, CH3, CH4
TDR Common	CH1+CH2, CH3+CH4
TDT Differential	CH5-CH6, CH7-CH8
TDT Crosstalk	CH3-CH4, CH7-CH8

Examples:

TDR Differential_CH1-CH2_EUT.wfm

TDR Single Ended_CH1.wfm

User1_TDR Common_CH1+CH2.wfm

TDT Differential_CH5-CH6_Session1.wfm

TDT Crosstalk_CH4_Jan31.wfm

View the Progress of Analysis

Related Topics

- [Select the Tests](#)
- [View and Select Connected Instruments](#)
- [Configure and Run the Tests](#)
- [View the Report](#)
- [View Test Related Files](#)

You can view the progress of the analysis in the Analyze panel. As the analysis of each test is complete, the result value is updated.

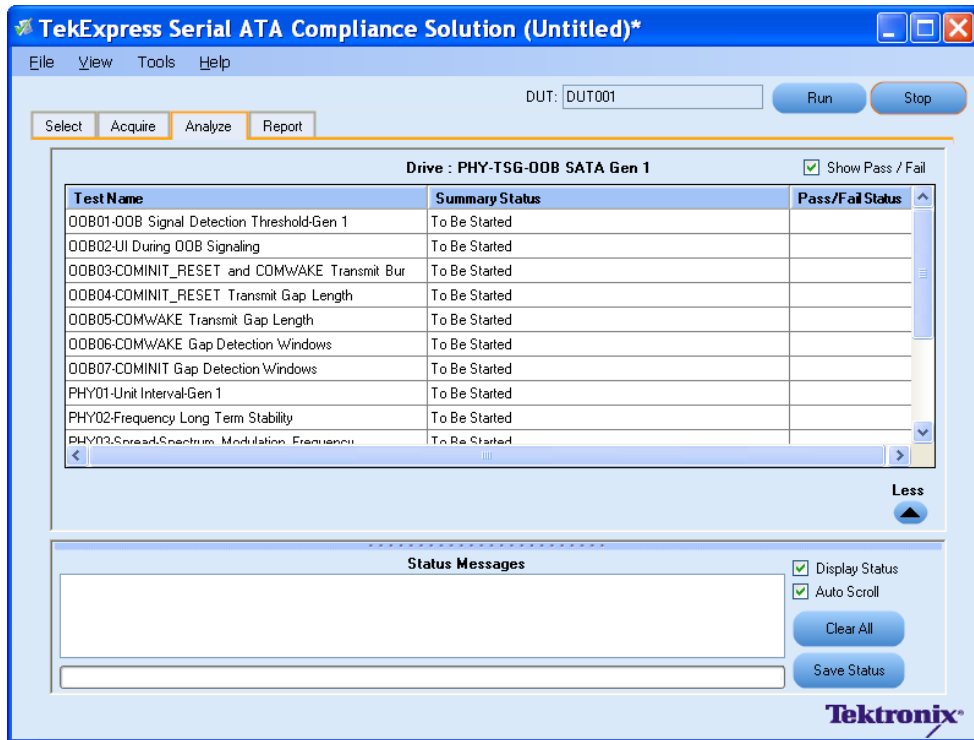

Analysis Table

The table contains the following:

- The test name.
- The status of the tests that are being run.

The tests that are not yet started are shown with a “To be Started” status. A summarized status of the currently running test is shown on the Status Messages panel.

More/Less

The **Status Messages** window timestamps all runtime messages and displays them. You can do the following:

- **Display Status:** Enable/Disable status messages.
- **Auto Scroll:** The status messages are scrolled automatically.
- **Clear All:** Clear all status messages in Status Window.
- **Save Status:** Save all status messages in text file. Displays a standard save file window and saves the status messages in the user specified file.

NOTE. *The Status Messages window is dockable and can be resized.*

View the Report

Related Topics

- [Select the Tests](#)
- [View and Select Connected Instruments](#)
- [Configure and Run the Tests](#)
- [View the Progress of Analysis](#)
- [View Test Related Files](#)

After the analysis, a report is automatically generated and displayed in the report panel. The report shows the results of the tests, including device information and pass/fail status of each test.

The Report View Area contains an HTML version of the report template. You can select any area of the report and copy it to the clipboard to make it available to other application.

The **View Scorecard** option opens the report in Microsoft Excel ¹.

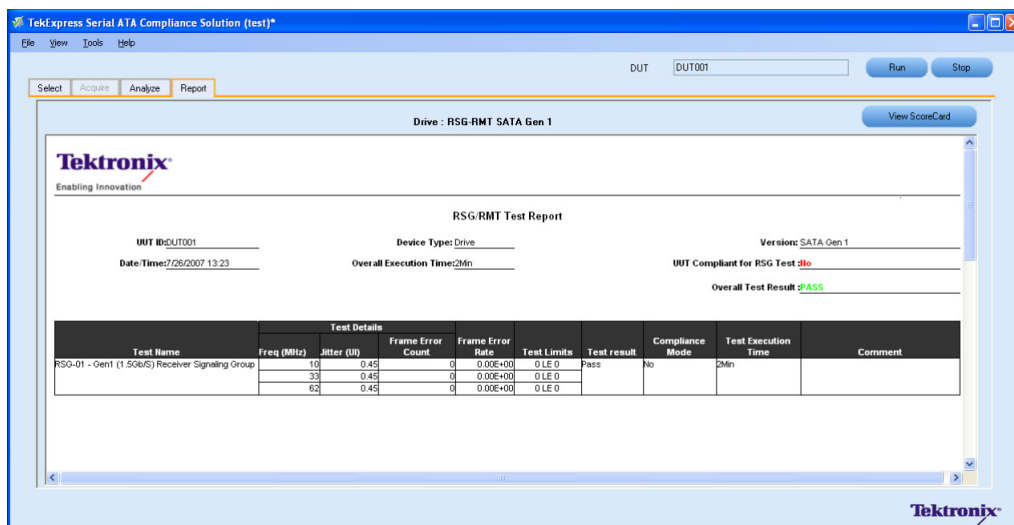

¹ You need to load Microsoft Excel 2002 before using the "View Scorecard" option.

View Test Related Files

Related Topics

[Application Directories and Usage](#)

All the test related files for currently selected tests are always saved under My Documents\My TekExpress\Serial ATA\Untitled Session.

When you save a session, it is saved with the session name under the path My Documents\My TekExpress\Serial ATA\SessionName for future references.

The session that is currently running will be stored in the same path as “Untitled” until you save it.



WARNING. Do not save a session named “Untitled” or “Backup” because there are application-specific files and are deleted when you exit the application.

A session folder can contain results for more than one DUT, and a DUT folder can contain more than one run data folder marked by date-time stamp as folder name.

Here is an example image of data storage:

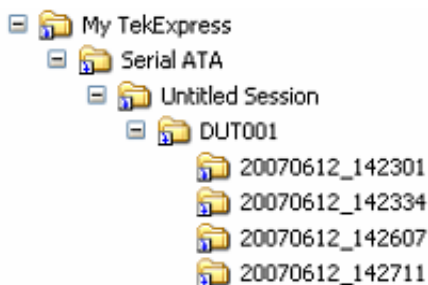

RSG-RMT Equipment Setup: Drive

You need the following equipment to set up the application:

Resource	Model Supported
Signal Source	Tektronix AWG7102 (Option 6)
Real Time Oscilloscope	<ul style="list-style-type: none">■ Tektronix DPO/DSA 72004, DPO/DSA 71604, DPO/DSA 71254, TDS6154C, and TDS6124C■ For Gen1-only testing, the following oscilloscopes are also acceptable: DPO/DSA 70804 or TDS6804B
RF Switch	Keithley S46-6666A
Frame Error Analyzer	Crescent Heart Software SATA II probe adapter
Test Fixture	Crescent Heart Software Fixture TF-SATA-NE-ZP, TF-SATA-FE-ZP
DUT	A SATA Drive to test

Connect the equipment as shown in the following diagram:

Setup diagram for Drive RSG-RMT test suite

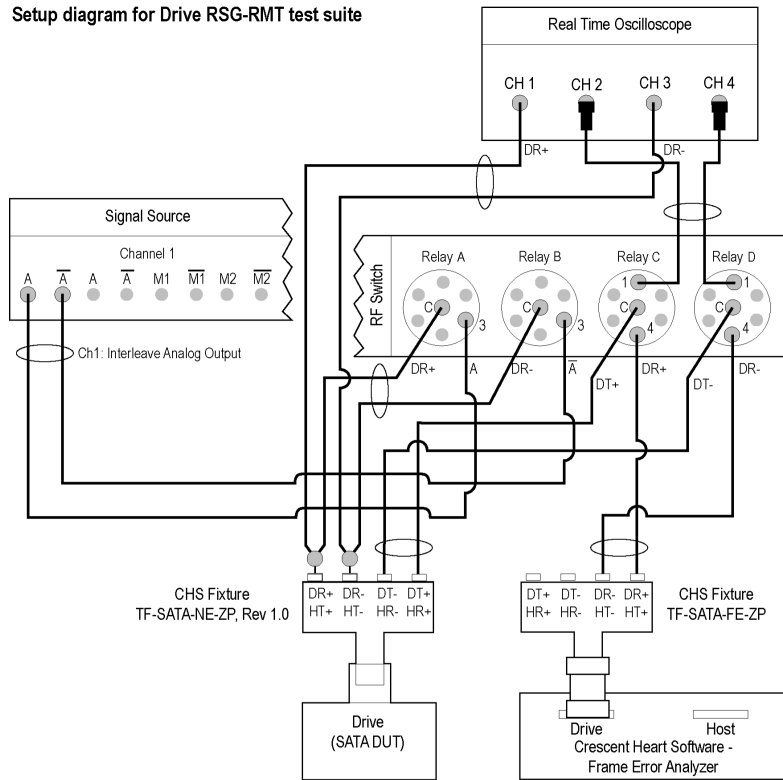

Matched pair of SMA cables 

6 dB attenuators 

NOTE: Terminate all unused outputs on the RF Switch with 50 ohms.
 Terminate all unused ports on the CHS test fixtures with 50 ohms.

CAUTION: Do not connect the output of the signal source directly to the CHS fixture. The signal must go through the RF Switch.

The CHS fixture notations in the schematic are with reference to Rev 1.0 of the fixture. If you are using fixtures before Rev 1.0, the fixture notations are in reverse order. For example, DT+/HR+ should be read as DR+/HT+.

If DUT Power Cycle sequence is automated using DC output of Signal Source, then do the following:
 -Connect Channel-1 of DC output to pin #14 (and pin #15 to GND) in case of 20 pin Molex connector of AT/ATX power supply.
 -Connect Channel-1 of DC output to pin #16 (and pin #17 to GND) in case of 24 pin Molex connector of AT/ATX power supply.

RSG-01 - Gen1 (1.5Gb/s) Receiver Signalling Group

Related Topics

[Equipment Setup Drive](#)

[Run RMT Receiver Margin Test1](#)

To run an RSG test on a SATA Drive to conformance standards defined by SATA-IO Interoperability, follow these steps:

NOTE. This test is applicable for both Drive and Host devices. The test procedure is the same for both drive and host except for a change in the connection diagram. Refer to [Figure 2](#) for Host connection diagram.

NOTE. All cables must be deskewed before performing this measurement.

1. Select **Drive** as the device type.
2. Select **RSG-RMT** as the Test Suite and SATA Gen 1 as the version.
3. Enter the DUT ID in the DUT field.
4. If you want to verify the test setup before running the test(s), click **Show Schematic**.
5. Select **RSG01-Gen1 (1.5Gb/s) Receiver Signalling Group** option.

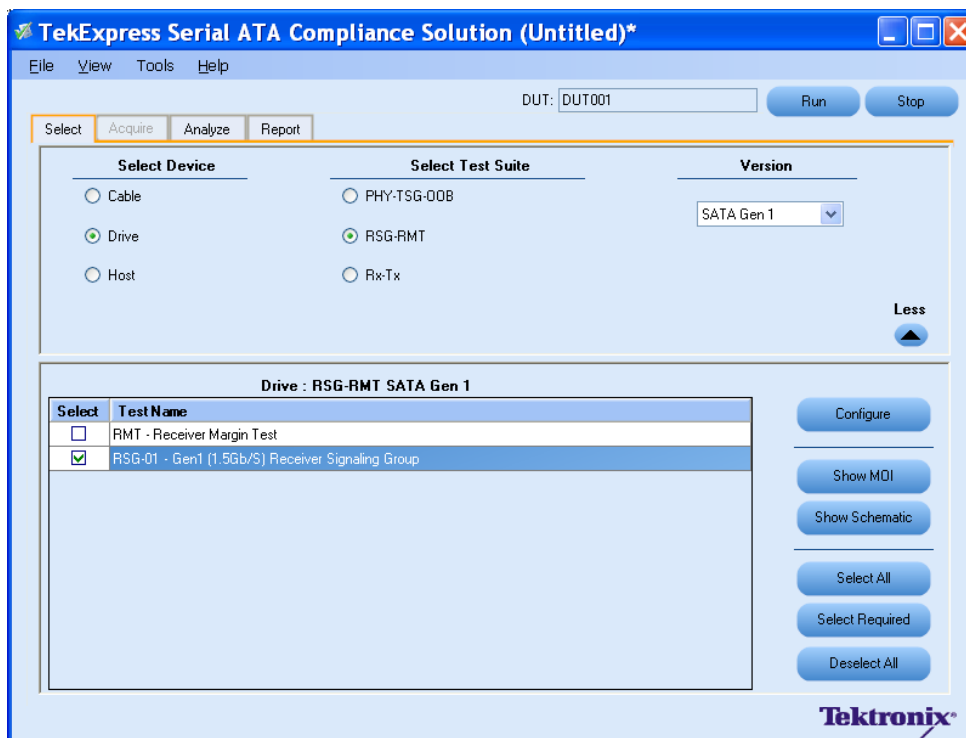

6. Click **Configure** to configure the test parameters. Observe that the default settings are in Compliance mode.

7. If you want to change the parameters, choose **User Defined Mode**. The message reports that the changes made to a test may no longer be compliant.
8. You can configure any test to help you analyze measurement results. To refer to the *Serial ATA Interoperability Program, MOI* document for information on how to configure the drive receiver tests, click **Show MOI** in the Select panel.
9. Click **Apply** to apply the new settings for the test selected. If you want to restore the default settings, click **Restore**. To close the dialog box, click **Close**.

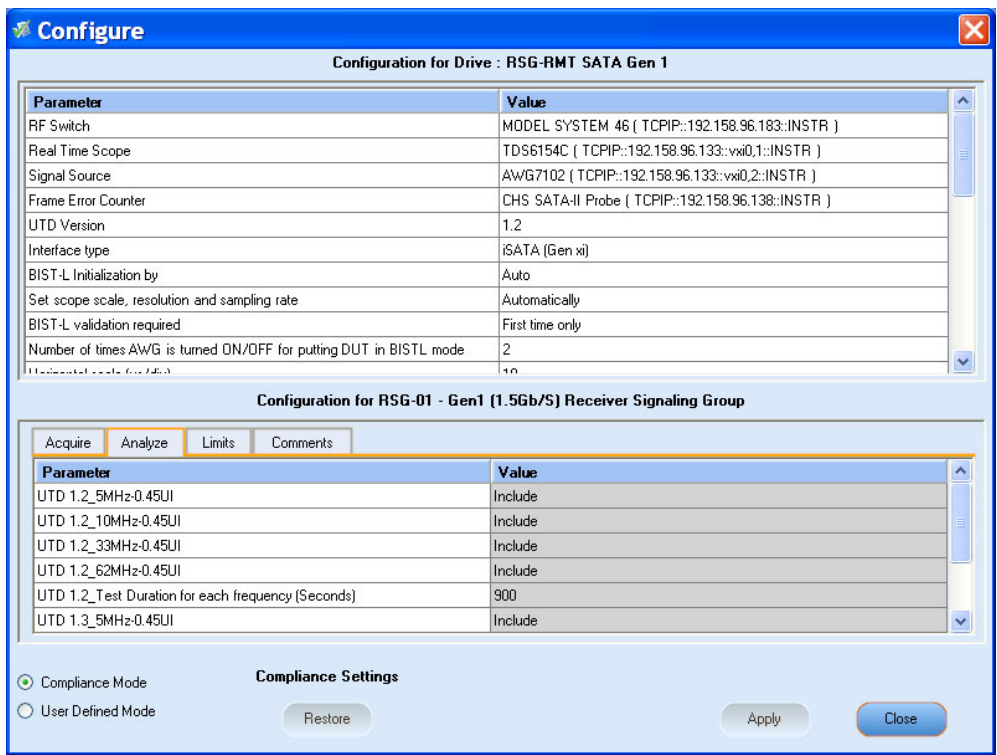

10. Click **Run** to run the selected tests.

The status of the tests is displayed in the Analyze panel.

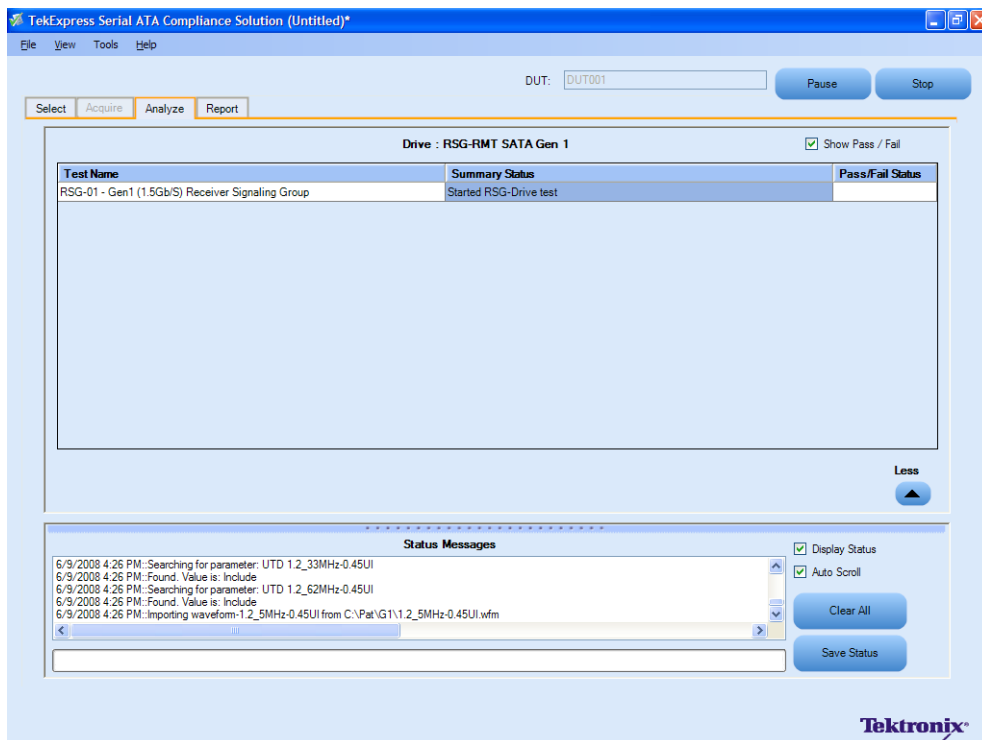

11. After the tests run successfully, a report is generated and displayed in the Report panel.

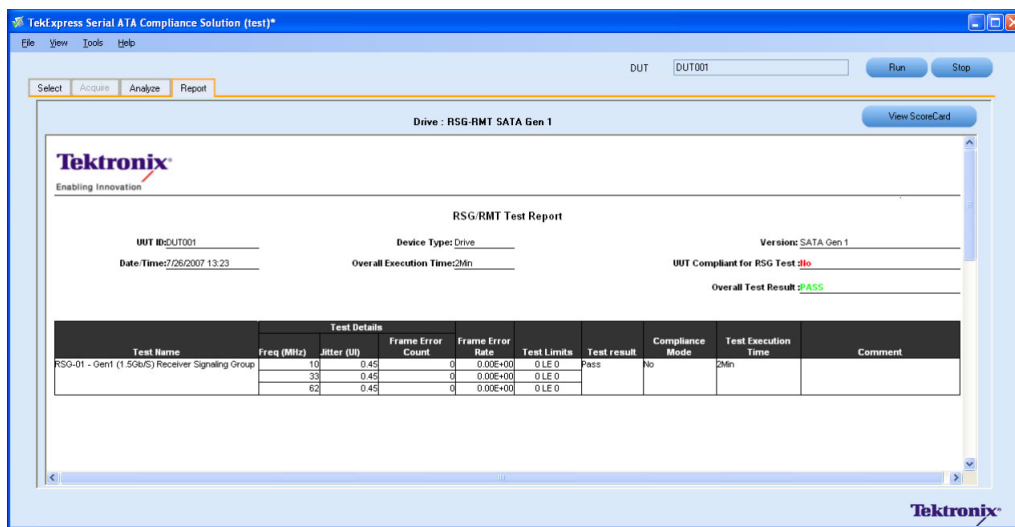

You can save the report using **File > Save Report As** option.

RMT- Receiver Margin Test

Related Topics
[Equipment Setup Drive](#)
[Run RSG01 Gen1 1.5Gbps Receiver Signalling Group](#)

To run an RMT test on a Drive device, do the following:

1. Select **Drive** as the Device type, select **RSG-RMT** test suite and **SATA Gen1** as the version.
2. Select **RMT - Receiver Margin Test** as the test to run.
3. Click **Show Schematic** to view the setup diagram for the application.

NOTE. Refer to the **Equipment Setup: Drive** section for the setup diagram.

4. For information on how to configure the RMT test parameters, refer to RSG - RMT Method of Implementation document by clicking **Show MOI**.
5. Click **Configure** to configure the test parameters.

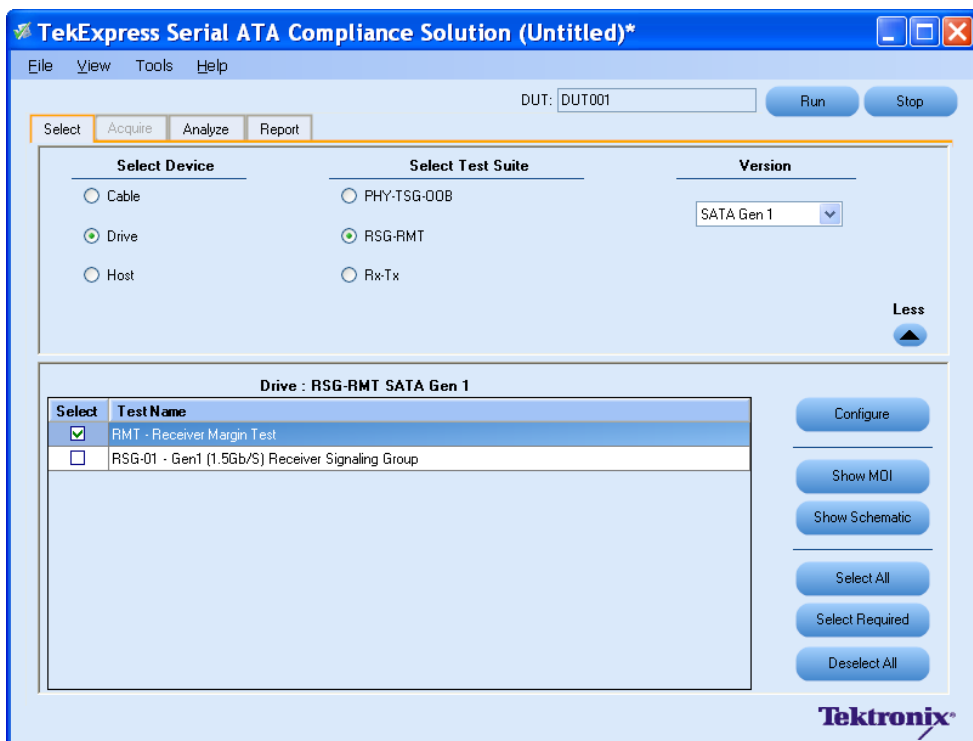

- The default settings are in **User Defined Mode**. Configure the Analyze parameters, such as the Start Frequency and End Frequency. Click **Apply** to apply the new settings. Click **Close**.

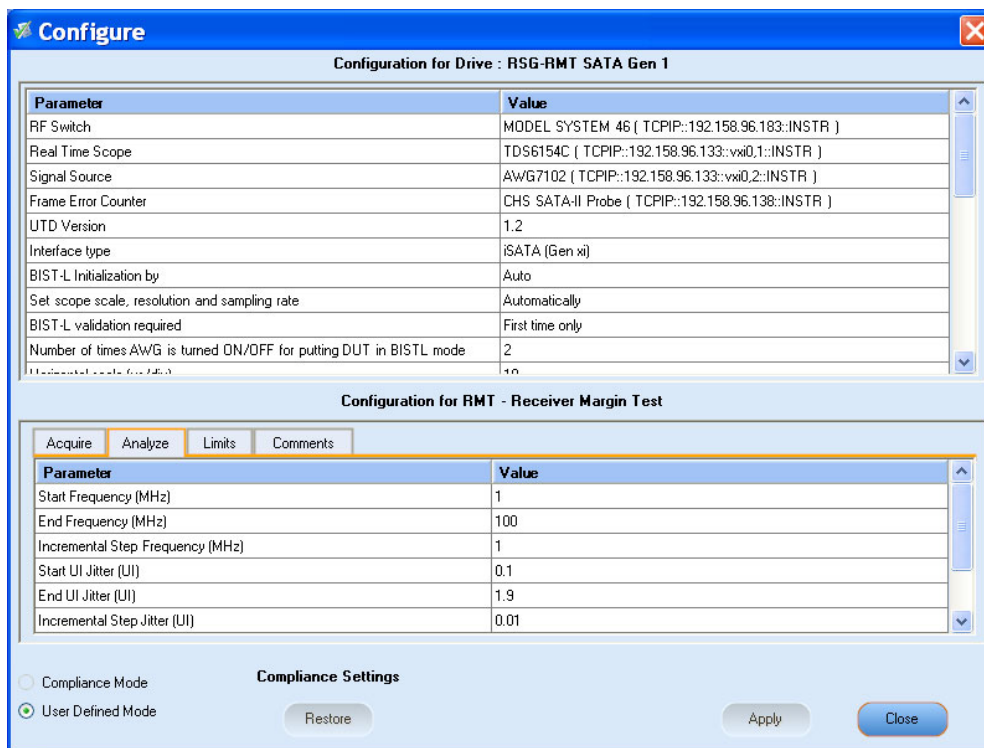

- Enter the DUT ID in the DUT field of Select panel, and click **Run**.
- The progress of the Analysis is displayed in the **Analyze** tab.

9. The test result report is displayed in the **Report** panel.

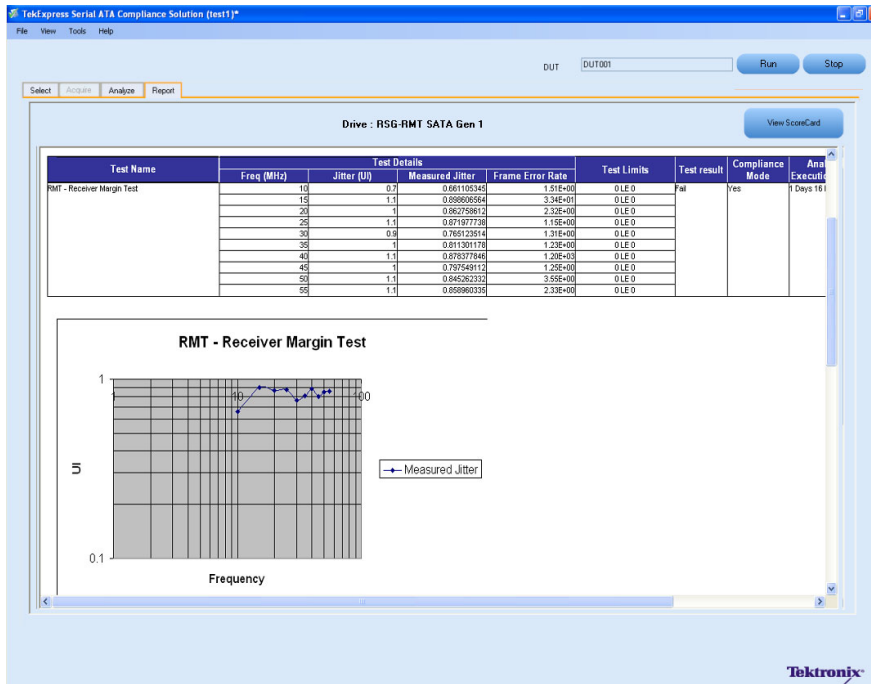

RSG-RMT Equipment Setup: Host

You need the following equipment to set up the application:

Resource	Model Supported
Signal Source	Tektronix AWG7102 (Option 6)
Real Time Oscilloscope	<ul style="list-style-type: none">■ Tektronix DPO/DSA 72004, DPO/DSA 71604, DPO/DSA 71254, TDS6154C, and TDS6124C■ For Gen1– only testing, the following oscilloscopes are also acceptable: DPO/DSA 70804 or TDS6804B
RF Switch	Keithley S46-6666A
Frame Error Analyzer	Crescent Heart Software SATA II probe adapter
Test Fixture	Crescent Heart Software Fixture TF-SATA-NE-ZP, TF-SATA-FE-ZP
DUT	A SATA Host to test

Connect the equipment as shown in the following diagram:

Setup diagram for Host RSG-RMT test suite

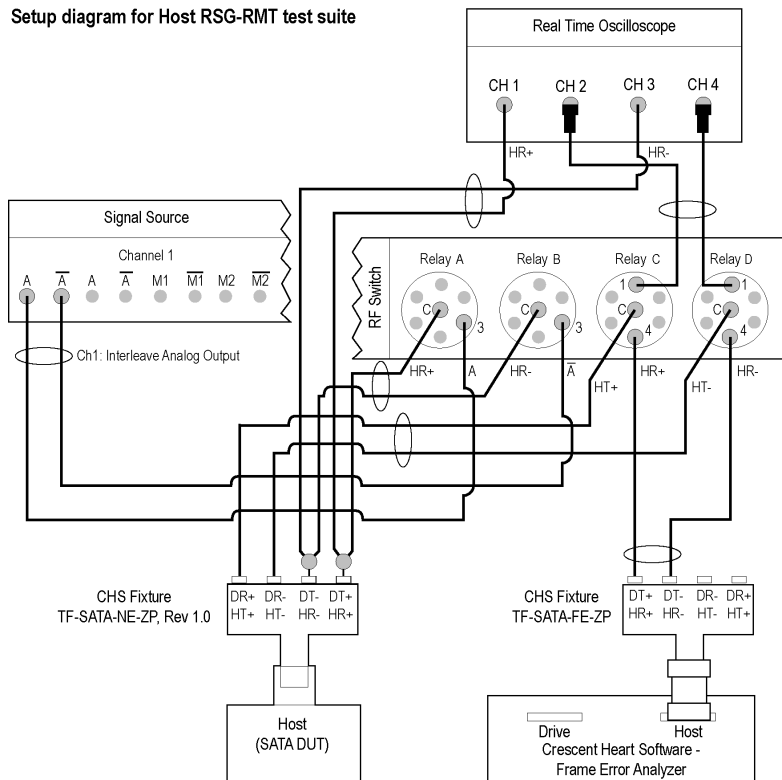

Matched pair of SMA cables

6 dB attenuators

NOTE: Terminate all unused outputs on the RF Switch with 50 ohms.
 Terminate all unused ports on the CHS test fixtures with 50 ohms.

CAUTION: Do not connect the output of the signal source directly to the CHS fixture. The signal must go through the RF Switch.

The CHS fixture notations in the schematic are with reference to Rev 1.0 of the fixture. If you are using fixtures before Rev 1.0, the fixture notations are in reverse order. For example, DT+/HR+ should be read as DR+/HT+.

If DUT Power Cycle sequence is automated using DC output of Signal Source, then do the following:
 -Connect Channel-1 of DC output to pin #14 (and pin #15 to GND) in case of 20 pin Molex connector of AT/ATX power supply.
 -Connect Channel-1 of DC output to pin #16 (and pin #17 to GND) in case of 24 pin Molex connector of AT/ATX power supply.

RSG-02 - Gen2 (3.0Gb/s) Receiver Signalling Group

Related Topics

[Equipment Setup Host](#)

[Run RMT Receiver Margin Test](#)

To run a RSG test on a SATA Host to conformance standards defined by SATA-IO Interoperability, follow these steps:

NOTE. The test procedure is the same for both drive and host except for a change in the connection diagram. Refer to [Figure 1](#) for the Drive connection diagram.

NOTE. All cables must be deskewed before performing this measurement.

1. Select **Host** as the device type.
2. Select **RSG-RMT** test suite and SATA Gen 2 as the version.
3. Enter the DUT ID in the DUT field.
4. If you want to verify the test setup before running the test(s), click **Show Schematic**.
5. Select **RSG-02 Gen2 (3.0Gb/s) Receiver Signalling Group** option.

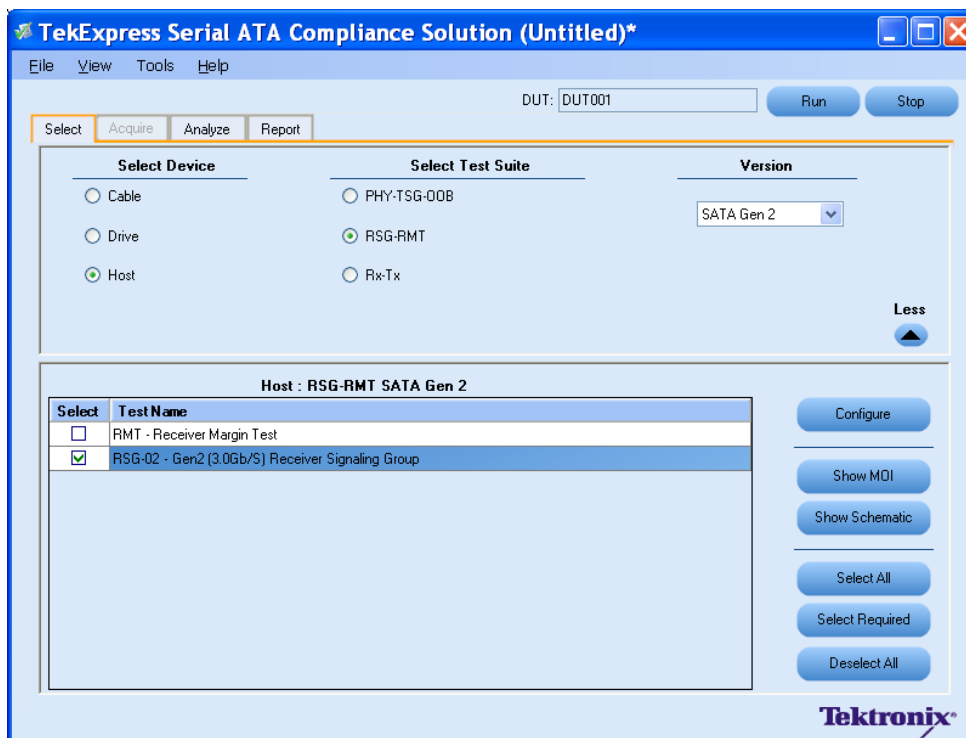

6. Click **Configure** if you want to configure the test parameters. Observe that the default settings are in Compliance mode.

7. If you want to change the parameters, choose **User Defined Mode**.
8. You can configure any test to help you analyze measurement results. To refer to the *Serial ATA Interoperability Program* MOI for information on how to configure the host receiver tests, click **Show MOI** in the Select panel.
9. Click **Apply** to apply the new settings for the selected test. If you want to restore the default settings, click **Restore**. To close the dialog box, click **Close**.

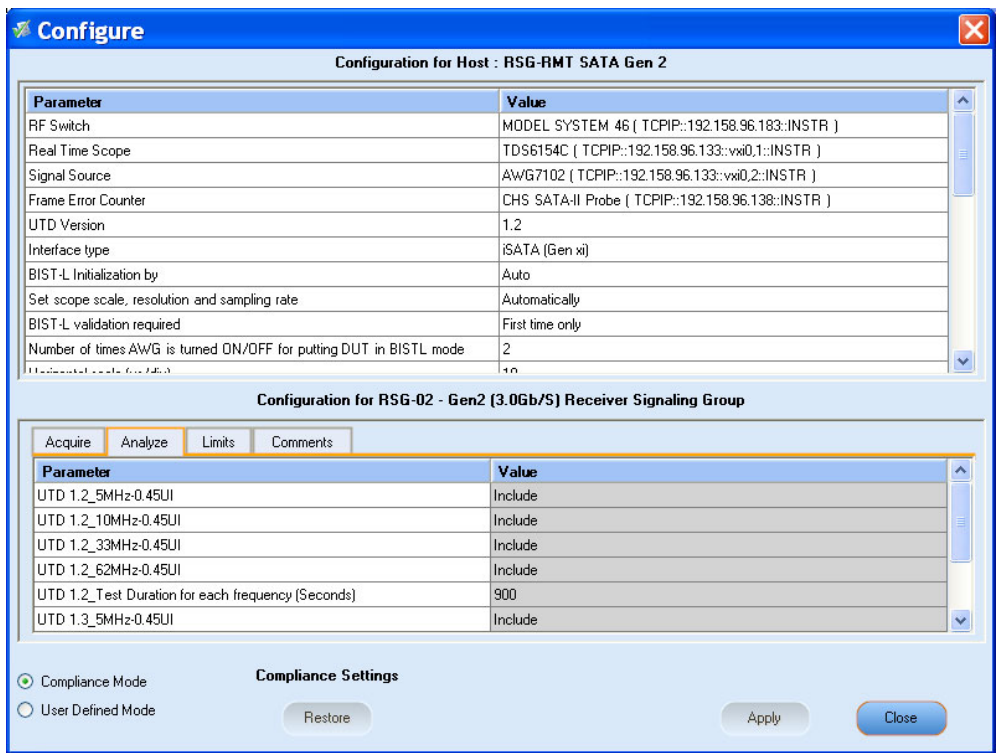

10. Click **Run** to run the selected tests. The status of the tests is displayed in the Analyze panel.

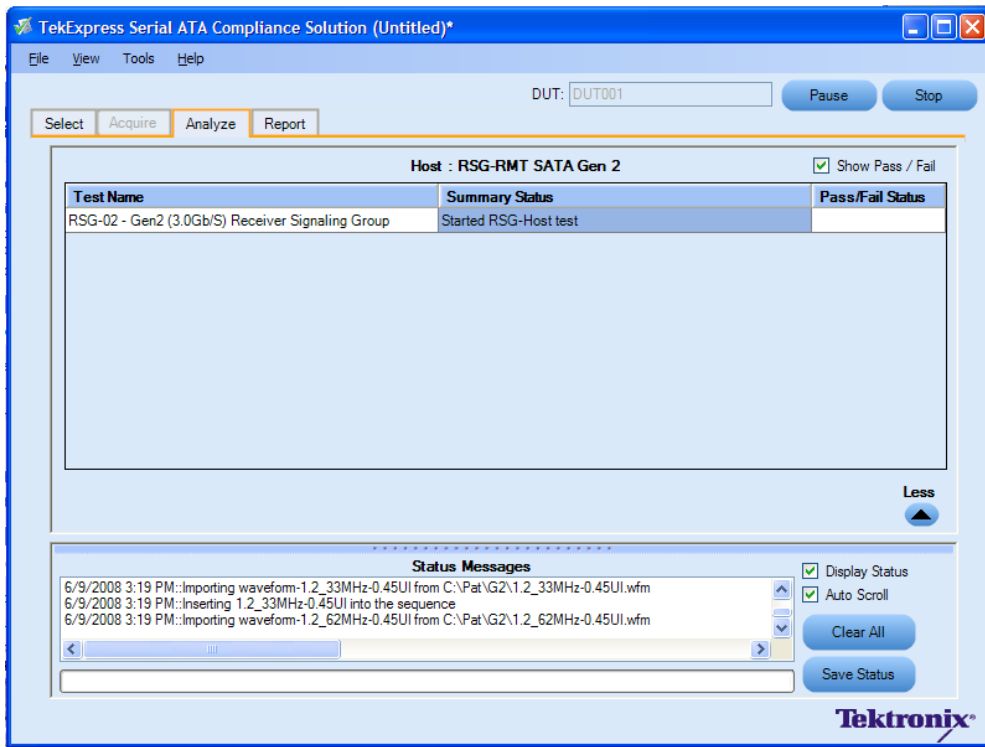

11. After the tests run successfully, a report is generated and displayed in the Report panel.

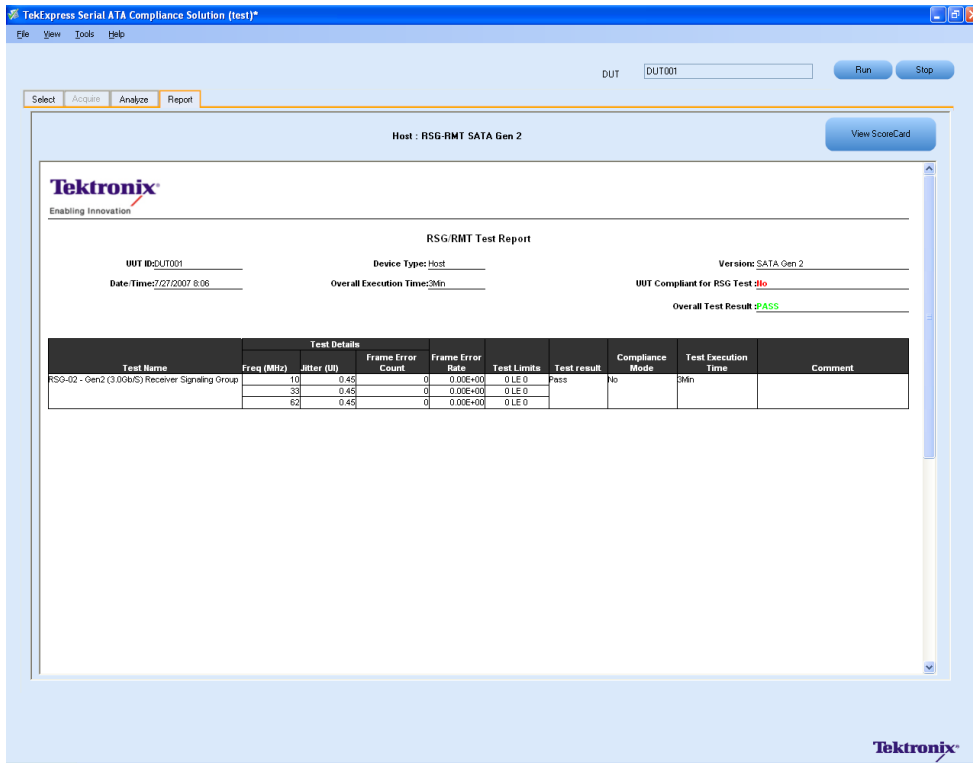

You can save the report using **File > Save Report As** menu option.

RMT- Receiver Margin Test

Related Topics

[Equipment Setup Host](#)

[Run RSG02 Gen2 3 0Gbs Receiver Signalling Group](#)

To run an RMT test on a Host device, do the following:

1. Select **Host** as the Device type.
2. Select **RSG-RMT** test suite and **SATA Gen2** as the version.
3. Select **RMT - Receiver Margin Test** as the test to run.
4. Click **Show Schematic** to view the setup diagram for the application.

NOTE. Refer to **Equipment Setup: Host** section, for the setup diagram.

5. For information on how to configure the RMT test parameters, refer to RSG - RMT Method of Implementation document by clicking **Show MOI**.
6. Click **Configure** to configure the test parameters.

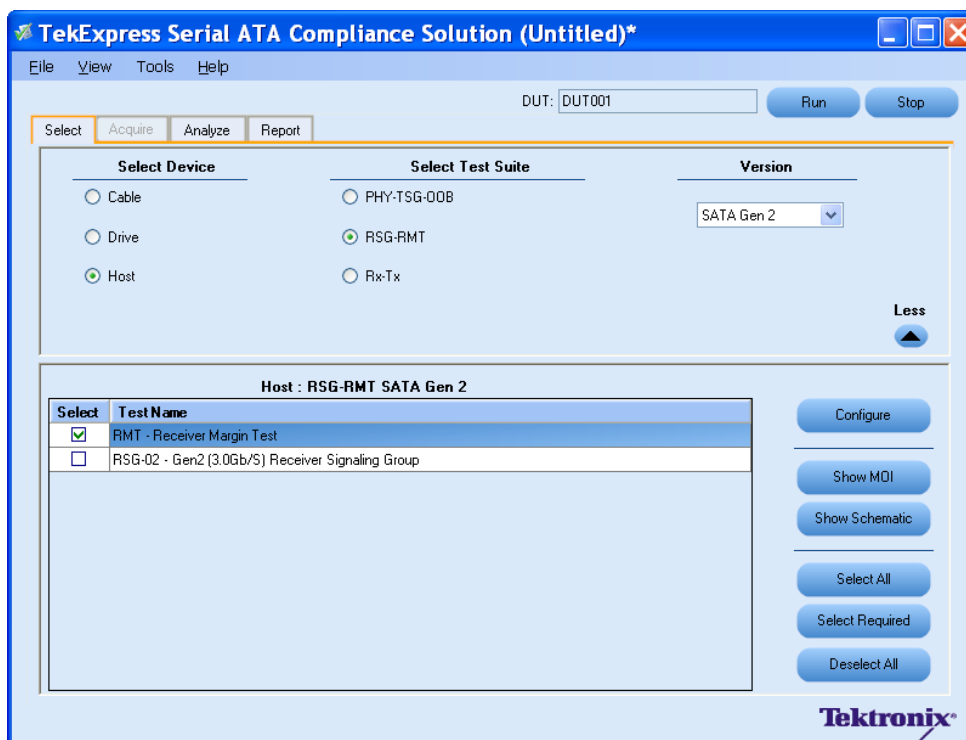

7. The default settings are in **User Defined Mode**. Configure the Analyze parameters, such as the Start Frequency and End Frequency.
8. Click **Apply** to apply the new settings. Click **Close**.

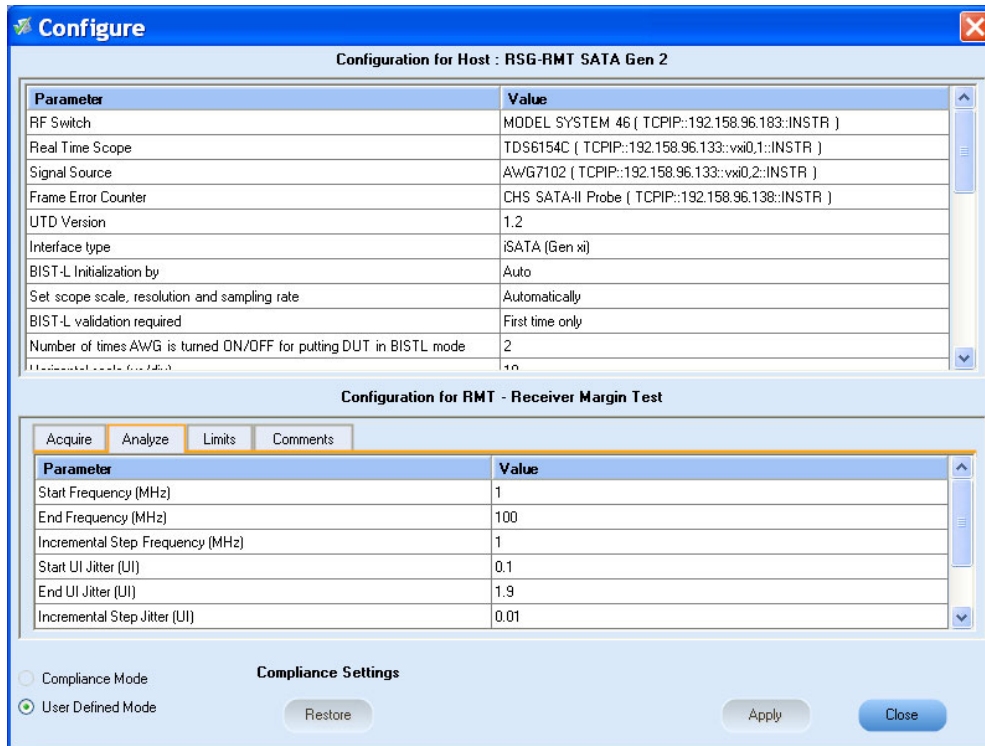

- Enter the DUT ID in the **DUT** field. Click **Run**. The progress of the analysis is displayed in the **Analysis** tab.

10. The test results are displayed in the **Report** panel.

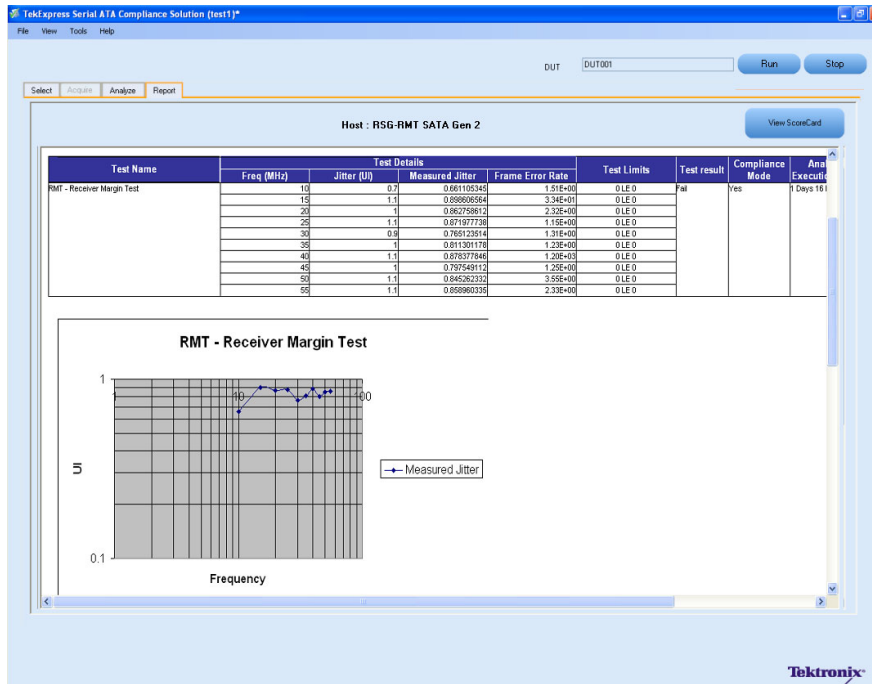

PHY-TSG-OOB Equipment Setup: Drive

You need the following equipment to set up the application:

Resource	Model Supported
Signal Source	Tektronix AWG7102 (Option 6)
Real Time Oscilloscope	<ul style="list-style-type: none"> ■ Tektronix DPO/DSA 72004, DPO/DSA 71604, DPO/DSA 71254, TDS6154C, and TDS6124C ■ For Gen1-only testing, the following oscilloscopes are also acceptable: DPO/DSA 70804 or TDS6804B
RF Switch	Keithley S46-6666A (optional)
Test Fixture	Crescent Heart Software Test Fixture TF-SATA-NE-ZP
DUT	A SATA Drive to test

Connect the equipment as shown in the following diagram:

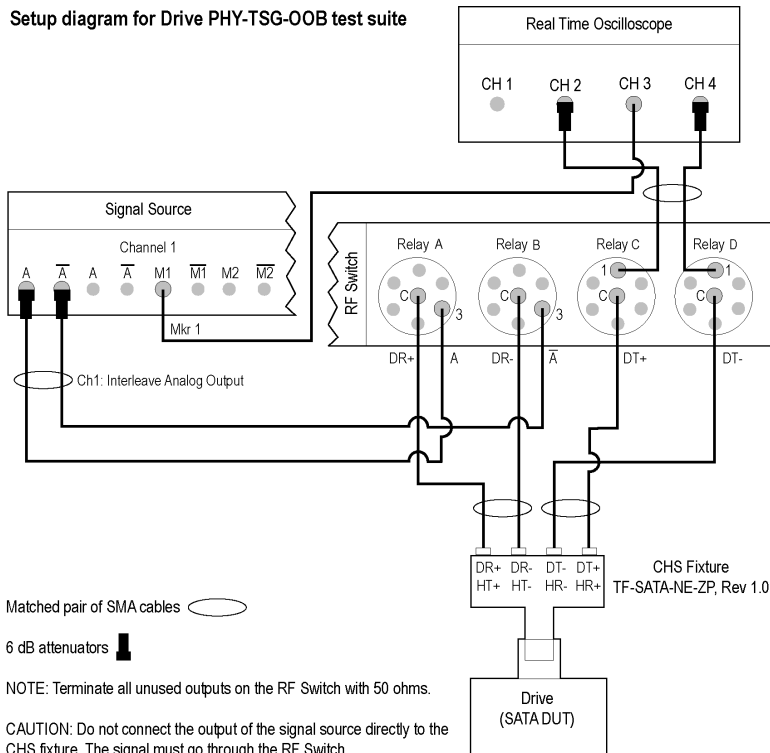

The CHS fixture notations in the schematic are with reference to Rev 1.0 of the fixture. If you are using fixtures before Rev 1.0, the fixture notations are in reverse order. For example, DT+/HR+ should be read as DR+/HT+.

If DUT Power Cycle sequence is automated using DC output of Signal Source, then do the following:
 -Connect Channel-1 of DC output to pin #14 (and pin #15 to GND) in case of 20 pin Molex connector of AT/ATX power supply.
 -Connect Channel-1 of DC output to pin #16 (and pin #17 to GND) in case of 24 pin Molex connector of AT/ATX power supply.

PHY01 - Unit Interval-Gen1 Test

To verify that the Unit Interval of the SATA Drive transmitter is within the conformance limit, follow these steps:

NOTE. The test procedure is same for both drive and host except for a change in the connection diagram. Refer to [Figure 3](#) for the Host connection diagram.

NOTE. All cables must be deskewed before performing this measurement.

1. Select **Drive** as the device type.
2. Select the **PHY-TSG-OOB** as the Test Suite and **SATA Gen1** as the version.
3. Select **PHY01 - Unit Interval-Gen1** option.
4. Enter the DUT ID in the DUT field.
5. If you want to verify the test setup before running the test(s), click **Show Schematic**.

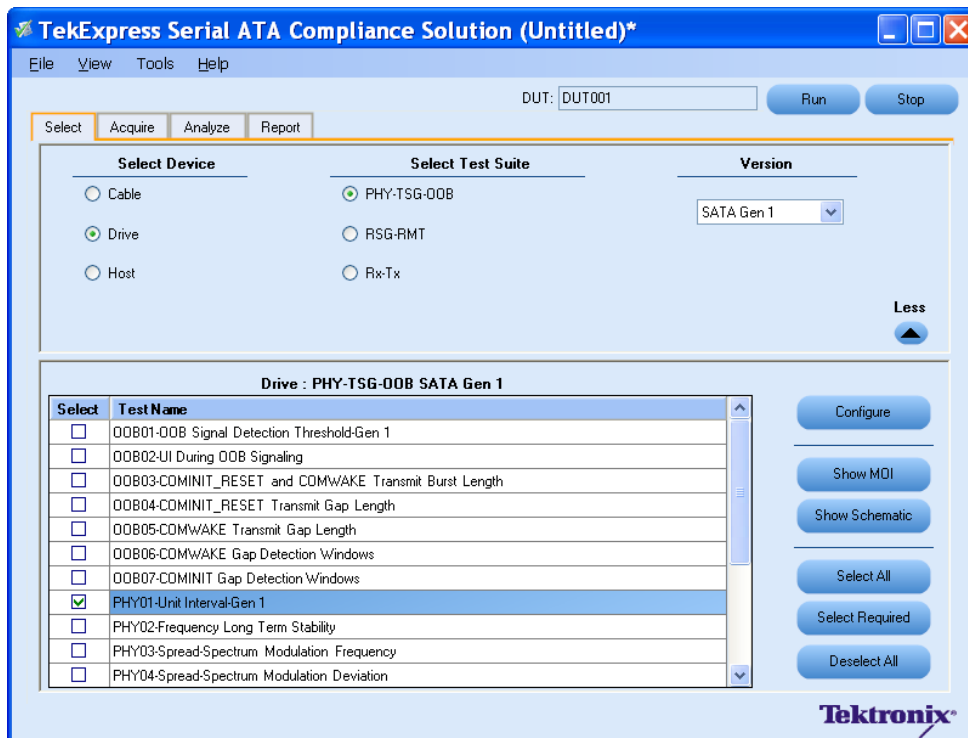

6. Click **Configure** to configure the test parameters. Observe that the default settings are in Compliance mode.

NOTE. The parameters that are not grayed are editable. To change the instrument related values, select from the drop-down list for each of the parameters.

7. You can configure any test to help you analyze measurement results. To refer to the *Serial ATA Interoperability Program MOI* document for information on how to configure the drive transmitter tests, click **Show MOI** in the Select panel.
8. Click **Apply** to apply the new settings for the selected test. If you want to restore the default settings, click **Restore** . To close the dialog box, click **Close**.

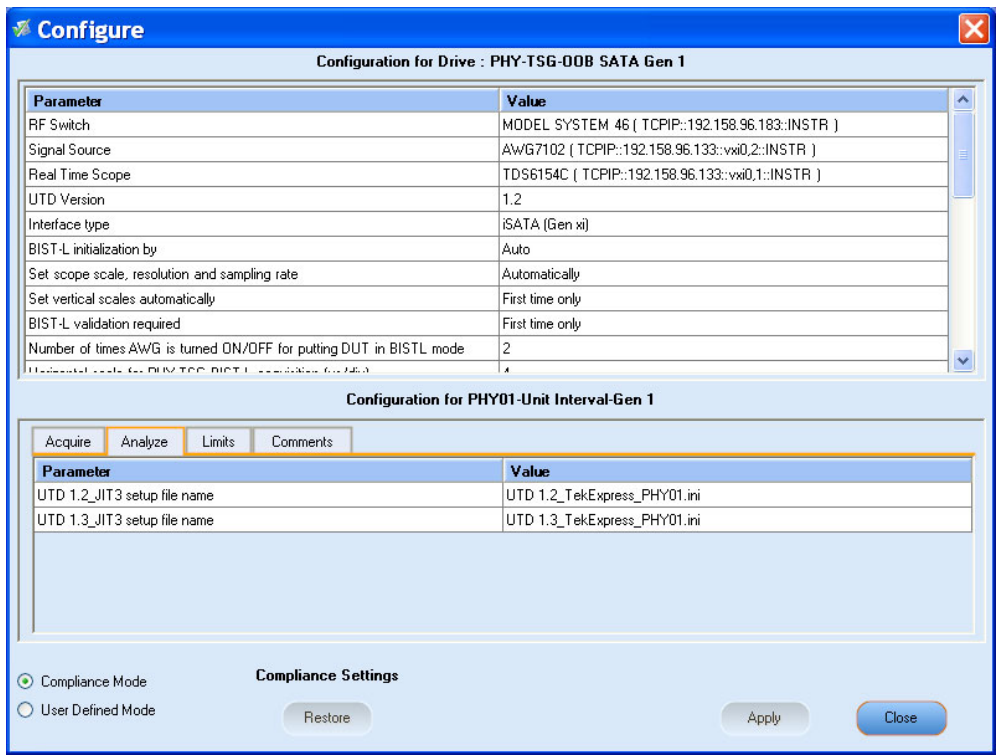

9. Click **Run** to run the selected tests.
10. The Acquire panel shows the status of the waveform acquisition.

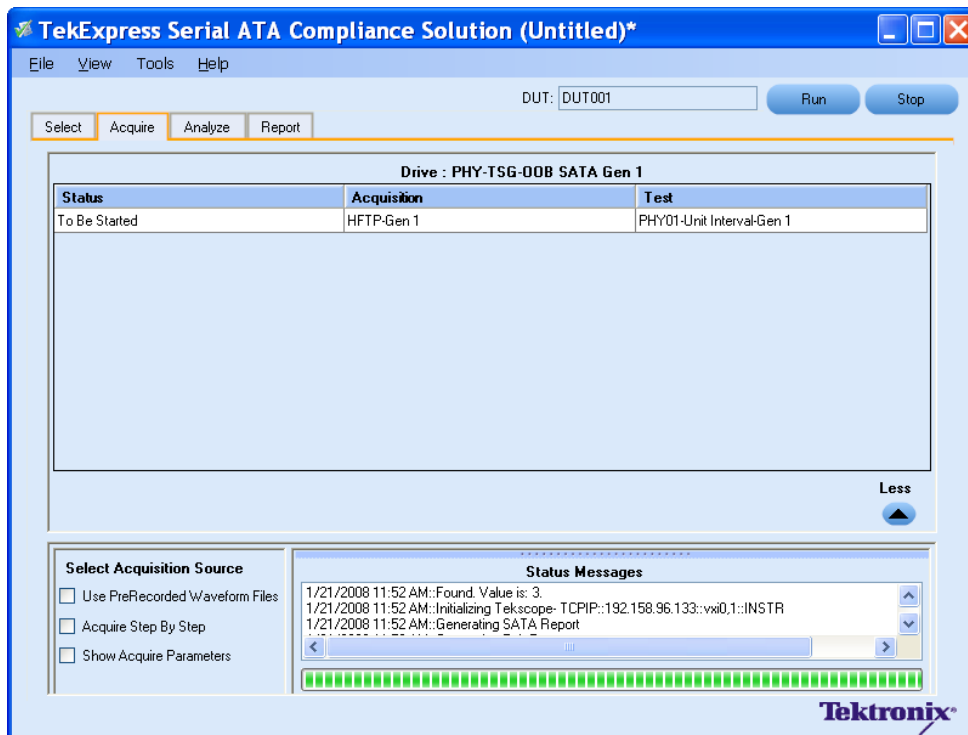

11. The status of the tests is displayed in the Analyze panel.

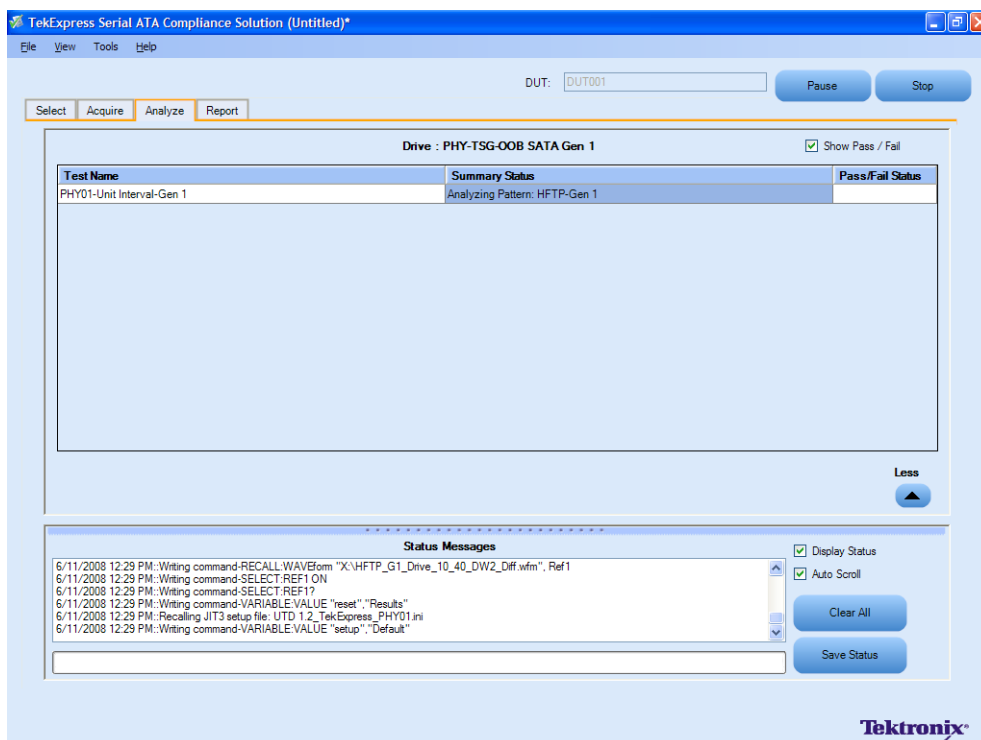

12. After the tests complete, a report is generated and displayed in the Report panel.

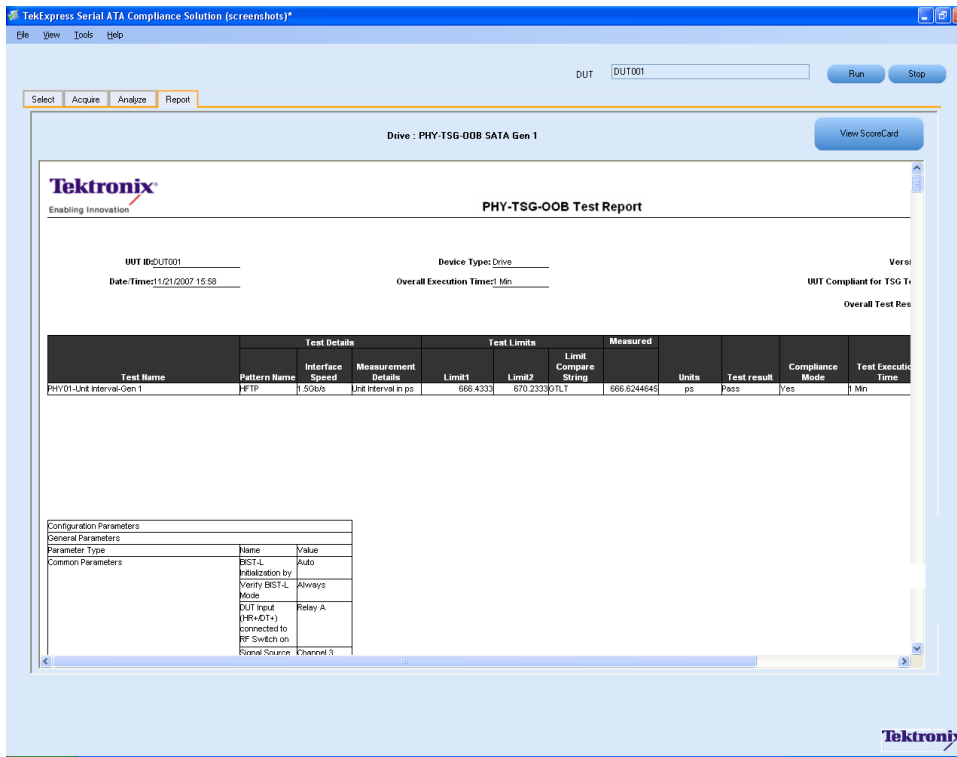

You can save the report using the **File > Save Report As** option.

TSG02 - Rise-Fall Time-Gen1 Test without RF Switch

To verify that the Rise/Fall time of the SATA Drive transmitter is within the conformance limits, follow these steps:

NOTE. Refer to [schematic](#) for connection diagram without the RF Switch.

NOTE. All cables must be deskewed before performing this measurement.

1. Select **Drive** as the device type.
2. Select **PHY-TSG-OOB** as the Test Suite and **SATA Gen1** as the version.
3. Enter the DUT ID in the DUT field.
4. Select the **TSG02 - Rise-Fall Time-Gen1** option.
5. If you want to verify the test setup before running the test(s), click **Show Schematic**.

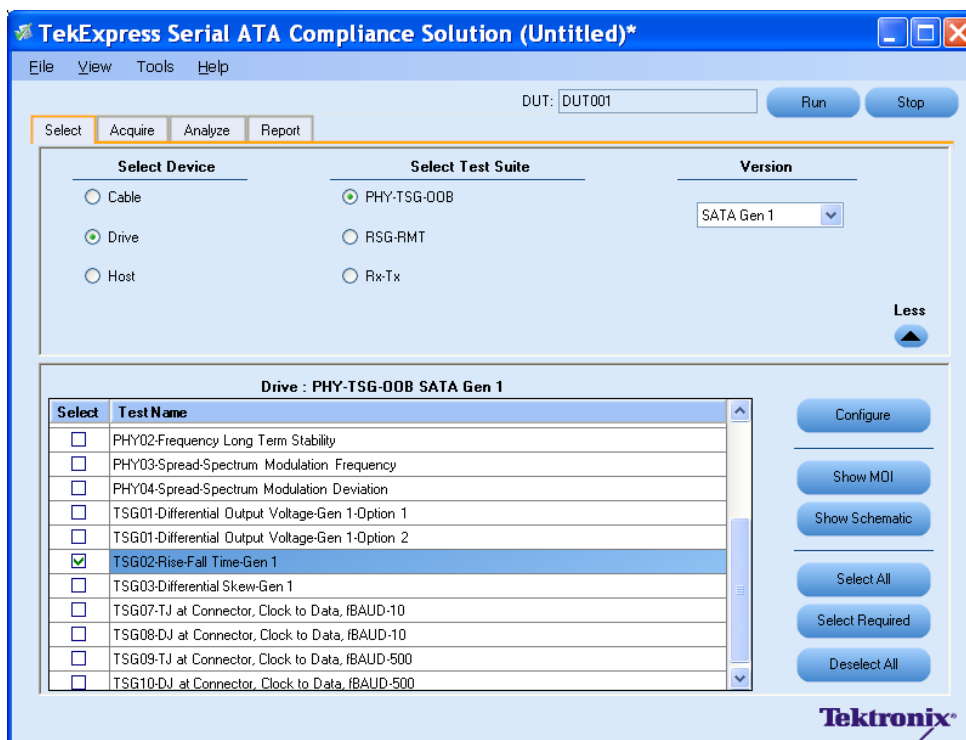

6. Click **Configure** to configure the test parameters. Observe that the default settings are in Compliance mode.

NOTE. The parameters that are not grayed are editable. To change the instrument related values, select from the drop-down list for each of the parameters.

7. You can configure any test to help you analyze measurement results. To refer to the *Serial ATA Interoperability Program MOI* document for information on how to configure the drive transmitter tests, click **Show MOI** in the Select panel.
8. To run the test without using RF Switch, choose the **Do not use** option from the drop-down list for the RF switch parameter in the Configure panel.

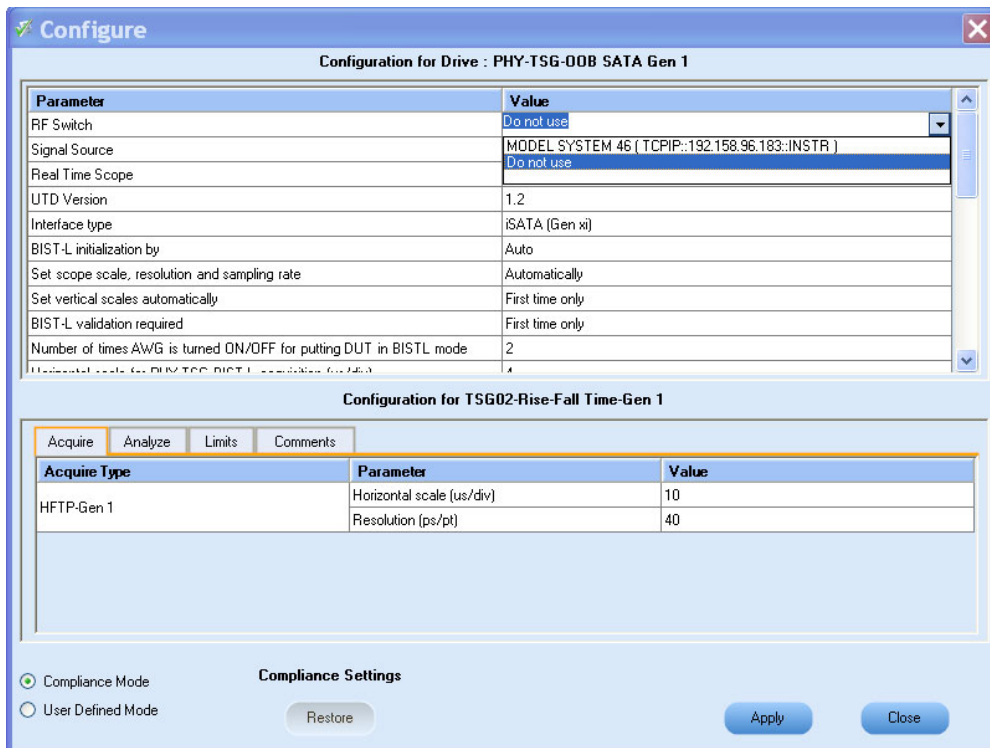

9. Click **Apply** to apply the new settings for the selected test and click **Close**.
10. Click **Run** to run the selected tests.
11. The Acquire panel shows the status of the waveform acquisition.

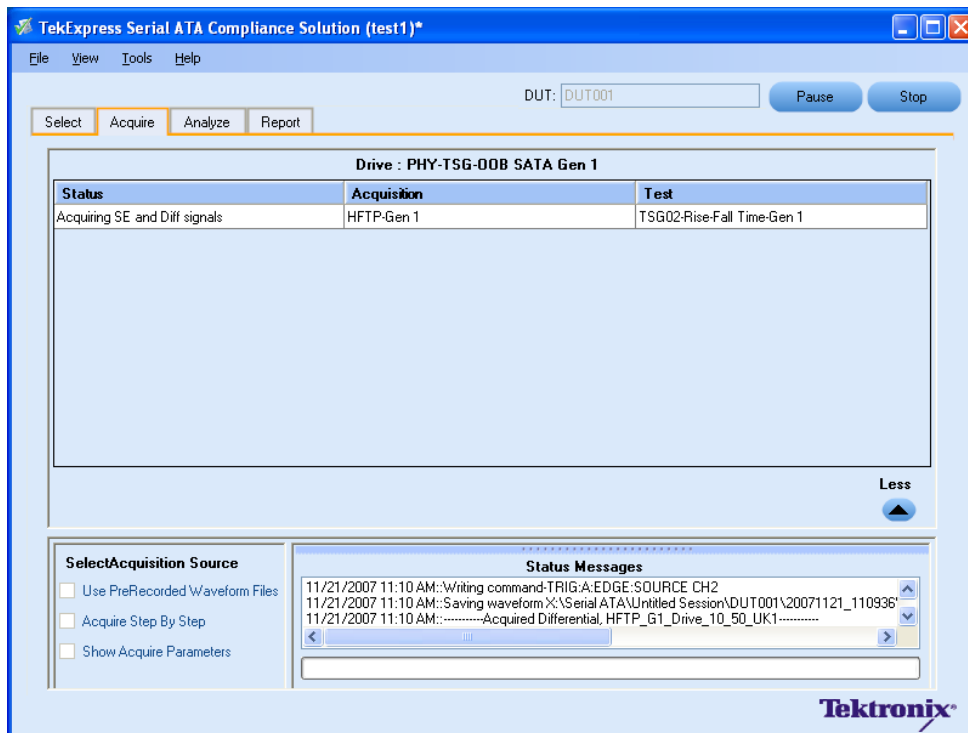

12. The status of the tests is displayed in the Analyze panel.

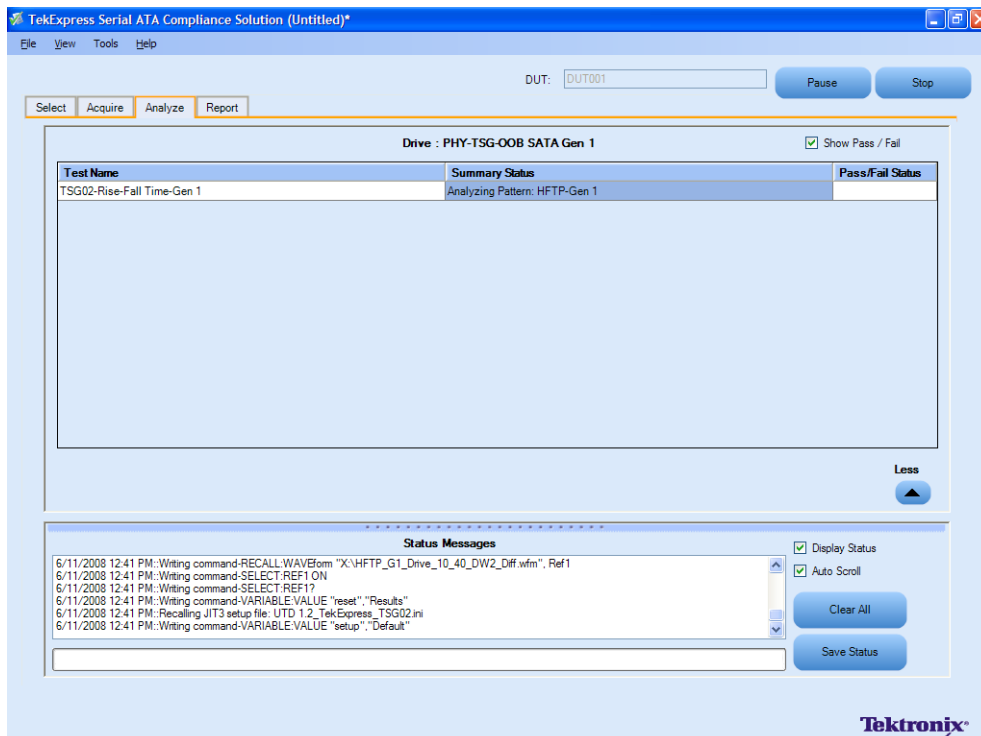

13. After the tests complete, a report is generated and displayed in the Report panel.

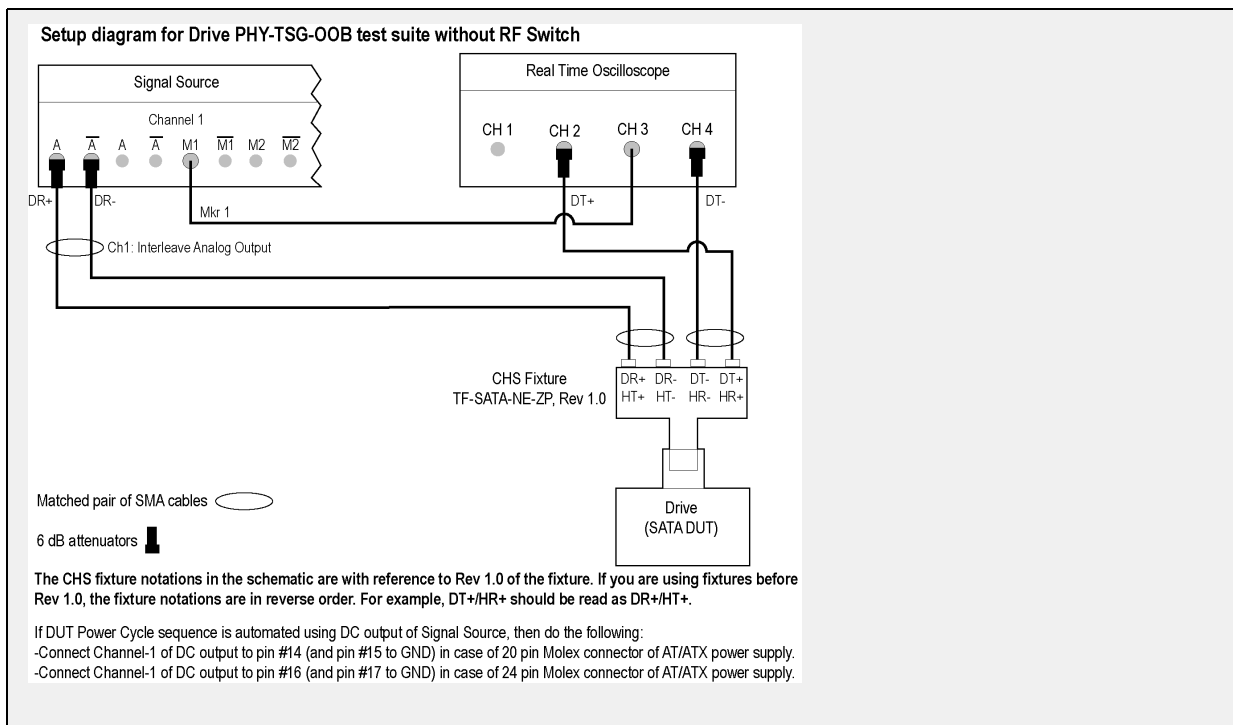
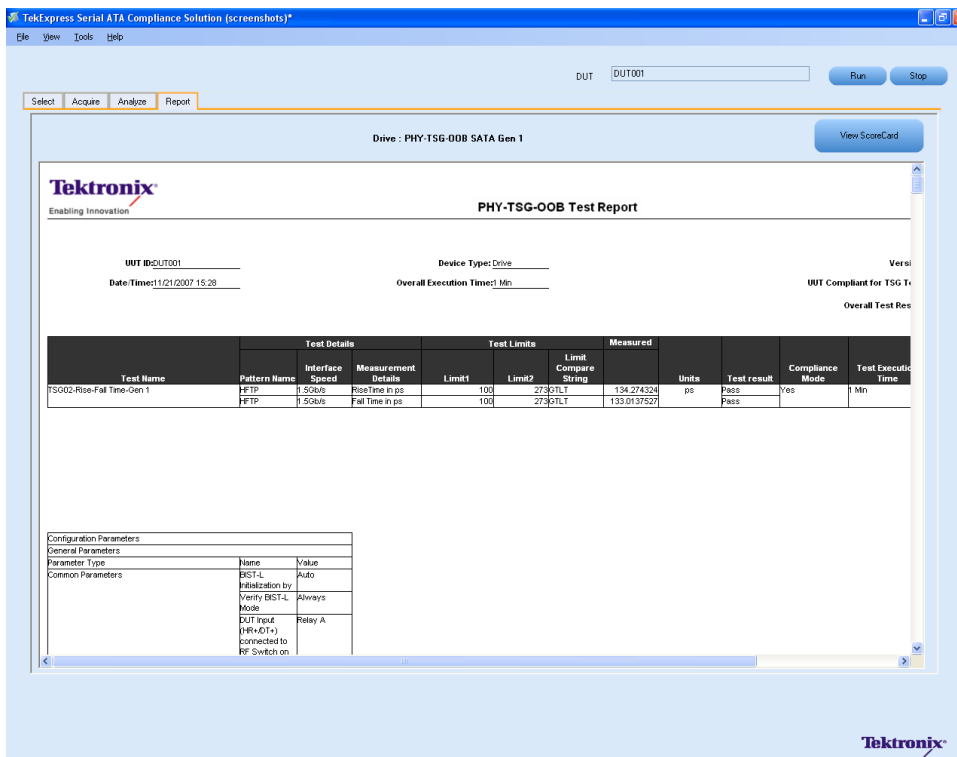

OOB01 - OOB Signal Detection Threshold-Gen1 Test

To verify that the OOB Signal Detection Threshold of the SATA Drive receiver is within the conformance limits, follow these steps:

NOTE. All cables must be deskewed before performing this measurement.

1. Select **Drive** as the device type.
2. Select **PHY-TSG-OOB** as the Test Suite and **SATA Gen1** as the version.
3. Enter the DUT ID in the DUT field.
4. Select the **OOB01 - OOB Signal Detection Threshold - Gen1** option.
5. If you want to verify the test setup before running the test(s), click **Show Schematic**.

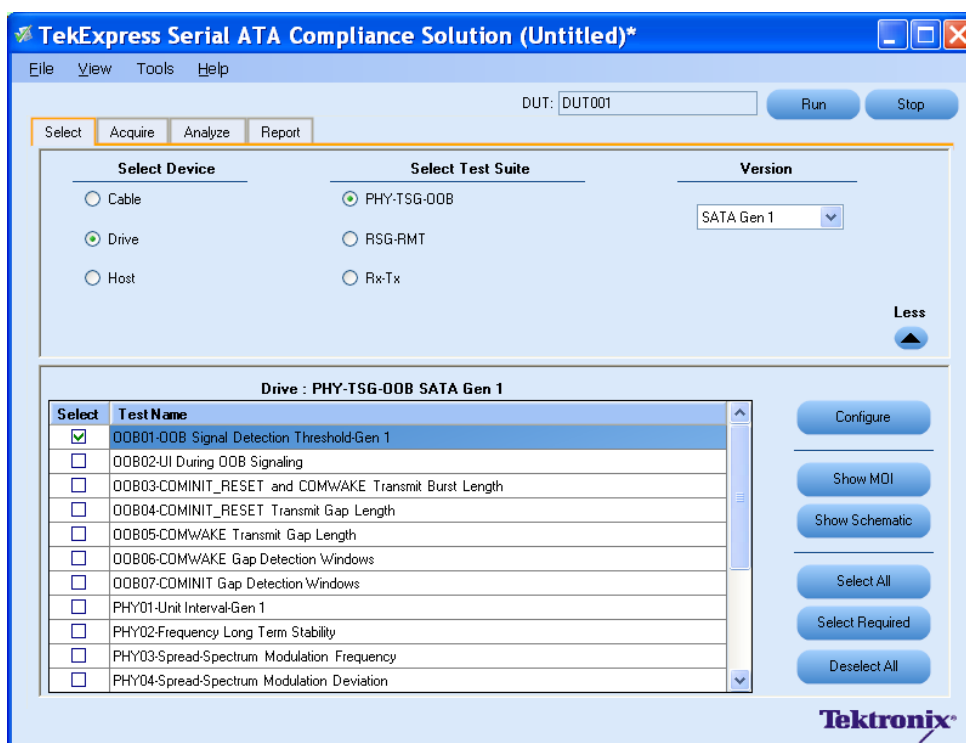

6. Click **Configure** to configure the test parameters. Observe that the default settings are in Compliance mode.
7. If you want to change the parameters, choose **User Defined Mode**. The message reports that the changes made to a test may no longer be compliant.

8. You can configure any test to help you analyze measurement results. To refer to the *Serial ATA Interoperability Program MOI* document for information on how to configure the drive receiver tests, click **Show MOI** in the Select panel.
9. Click **Apply** to apply the new settings for the test selected. If you want to restore the default settings, click **Restore**. To close the dialog box, click **Close**.

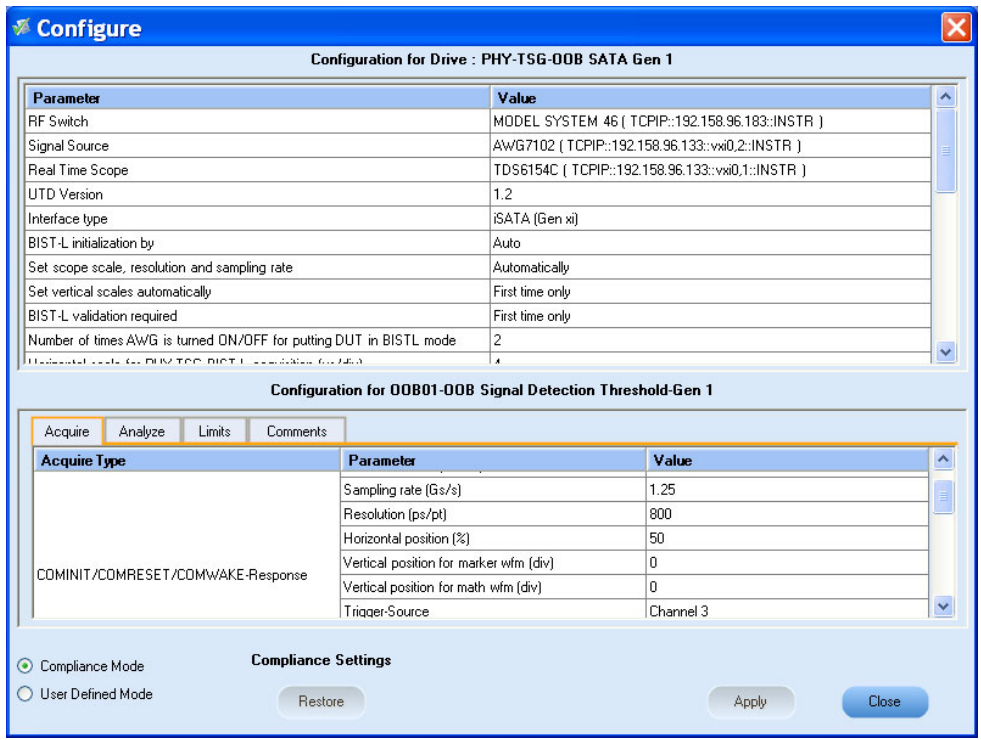

10. Click **Run** to run the selected tests.
11. The application automatically switches to the Acquire panel showing the waveform acquisition status.

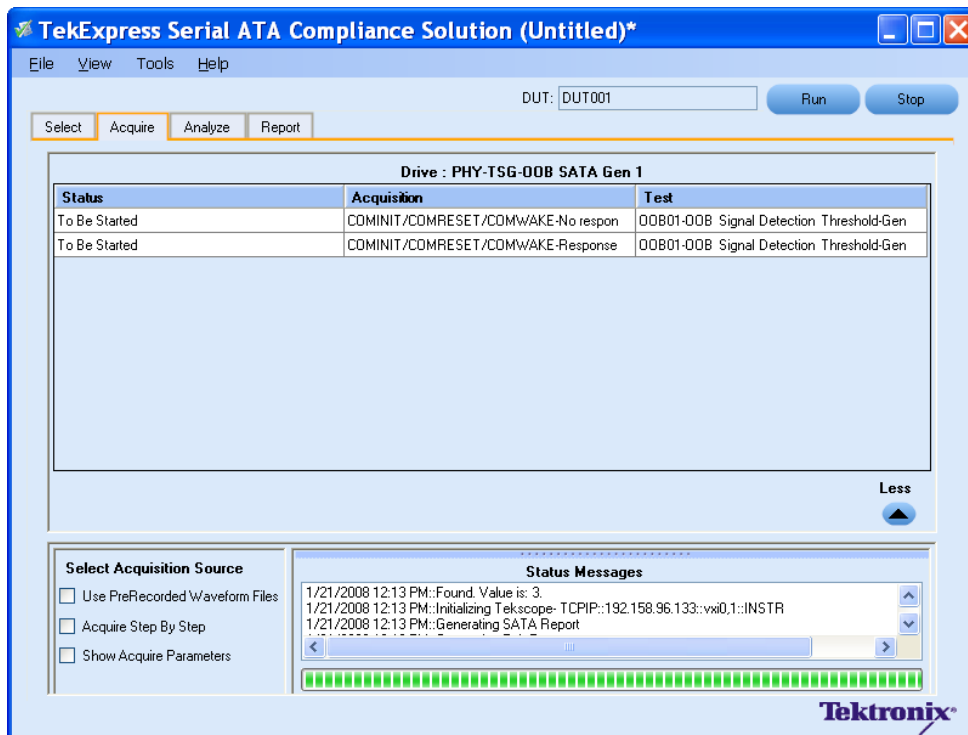

12. The status of the tests is displayed in the Analyze panel.

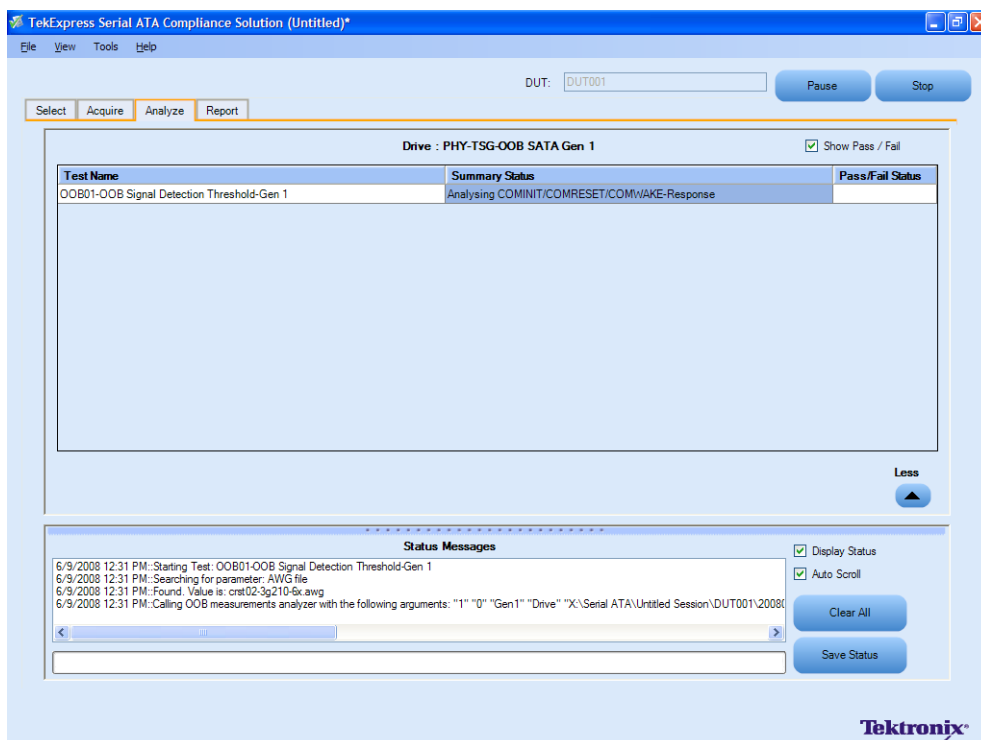

13. After the tests complete, a report is generated and displayed in the Report panel.

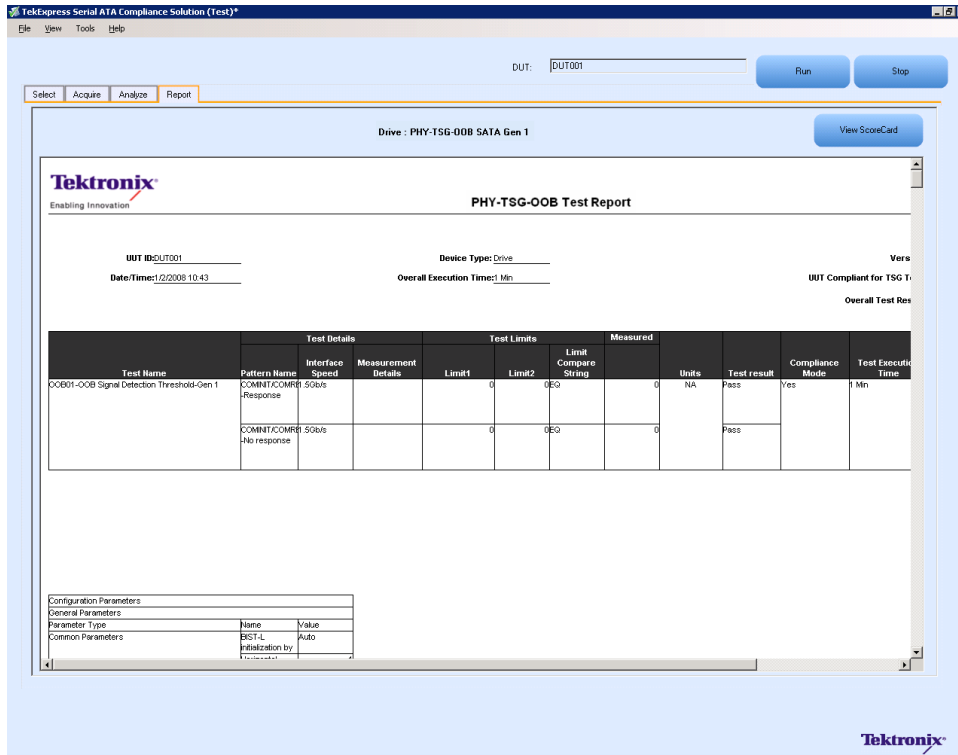

PHY-TSG-OOB Equipment Setup:Host

You need the following equipment to set up the application:

Resource	Model Supported
Signal Source	Tektronix AWG7102 (Option 6)
Real Time Oscilloscope	<ul style="list-style-type: none"> ■ Tektronix DPO/DSA 72004, DPO/DSA 71604, DPO/DSA 71254, TDS6154C, and TDS6124C ■ For Gen1-only testing, the following oscilloscopes are also acceptable: DPO/DSA 70804 or TDS6804B
RF Switch	Keithley S46-6666A
Test Fixture	Crescent Heart Software test fixture, TF-SATA-NE-ZP
DUT	A SATA Host to test

Connect the equipment as shown in the following diagram:

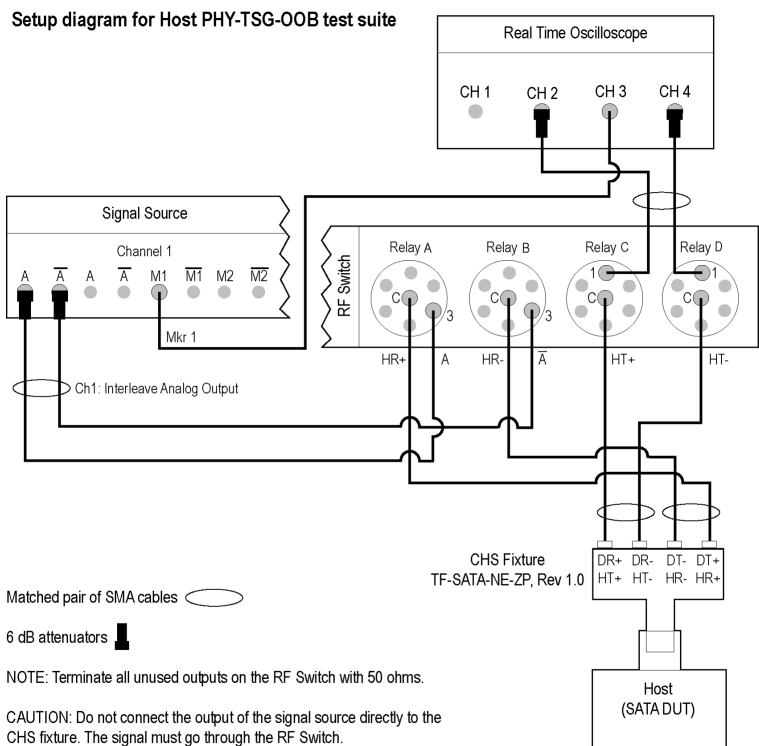

Matched pair of SMA cables

6 dB attenuators

NOTE: Terminate all unused outputs on the RF Switch with 50 ohms.

CAUTION: Do not connect the output of the signal source directly to the CHS fixture. The signal must go through the RF Switch.

The CHS fixture notations in the schematic are with reference to Rev 1.0 of the fixture. If you are using fixtures before Rev 1.0, the fixture notations are in reverse order. For example, DT+/HR+ should be read as DR+/HT+.

If DUT Power Cycle sequence is automated using DC output of Signal Source, then do the following:

- Connect Channel-1 of DC output to pin #14 (and pin #15 to GND) in case of 20 pin Molex connector of AT/ATX power supply.
- Connect Channel-1 of DC output to pin #16 (and pin #17 to GND) in case of 24 pin Molex connector of AT/ATX power supply.

TSG03 - Differential Skew-Gen 2 Test

To verify that the differential skew of the SATA Host transmitter is within the conformance limits, follow these steps:

NOTE. The test procedure is same for both drive and host except for a change in the connection diagram. Refer to [Figure 4](#) for the Drive connection diagram.

NOTE. All cables must be deskewed before performing this measurement.

1. Select **Host** as the device type.
2. Select **PHY-TSG-OOB** as the Test Suite and **SATA Gen2** as the version.
3. Enter the DUT ID in the DUT field.
4. Select the **TSG03 - Differential Skew-Gen2** option.
5. If you want to verify the test setup before running the test(s), click **Show Schematic**.

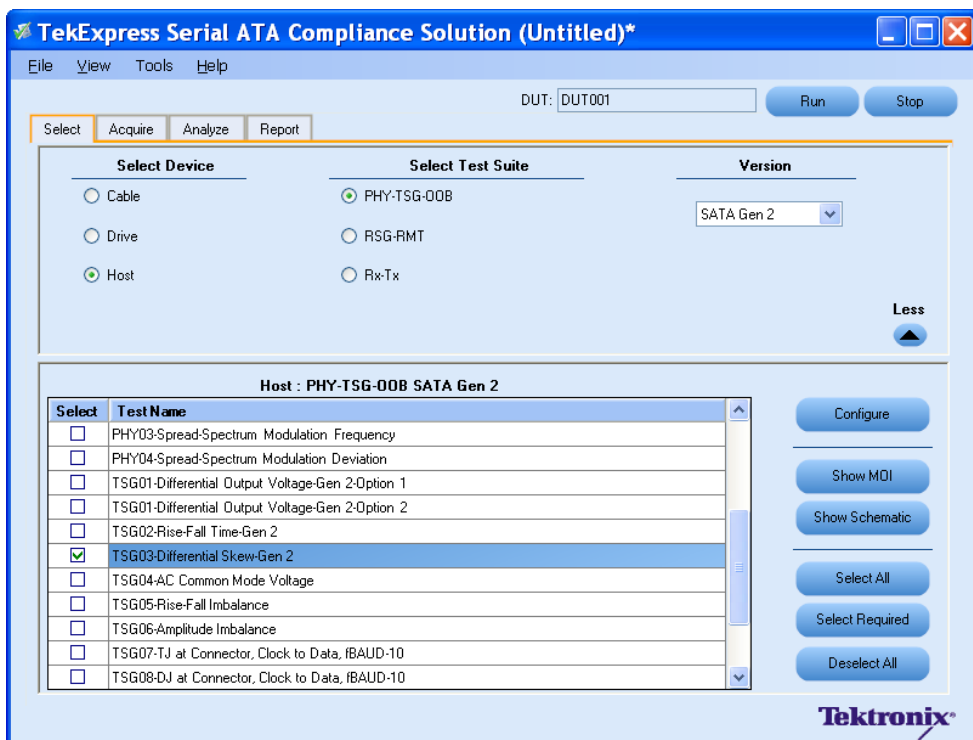

6. Click **Configure** to configure the test parameters. Observe that the default settings are in Compliance mode.

NOTE. The parameters that are not grayed are editable. To change the instrument related values, select from the drop-down list for each of the parameters.

7. You can configure any test to help you analyze measurement results. To refer to the *Serial ATA Interoperability Program* MOI document for information on how to configure the drive transmitter tests, click **Show MOI** in the Select panel.
8. Click **Apply** to apply the new settings for the test selected. If you want to restore the default settings, click **Restore** . To close the dialog box, click **Close**.

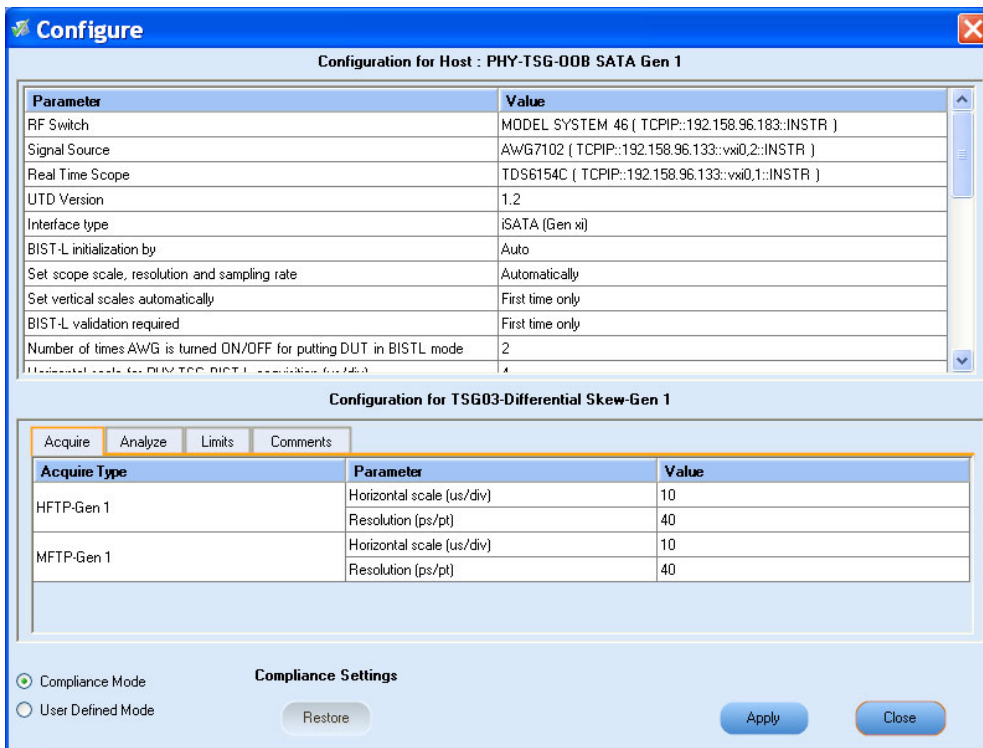

9. Click **Run** to run the selected tests.

10. The Acquire panel shows the status of the waveform acquisition.

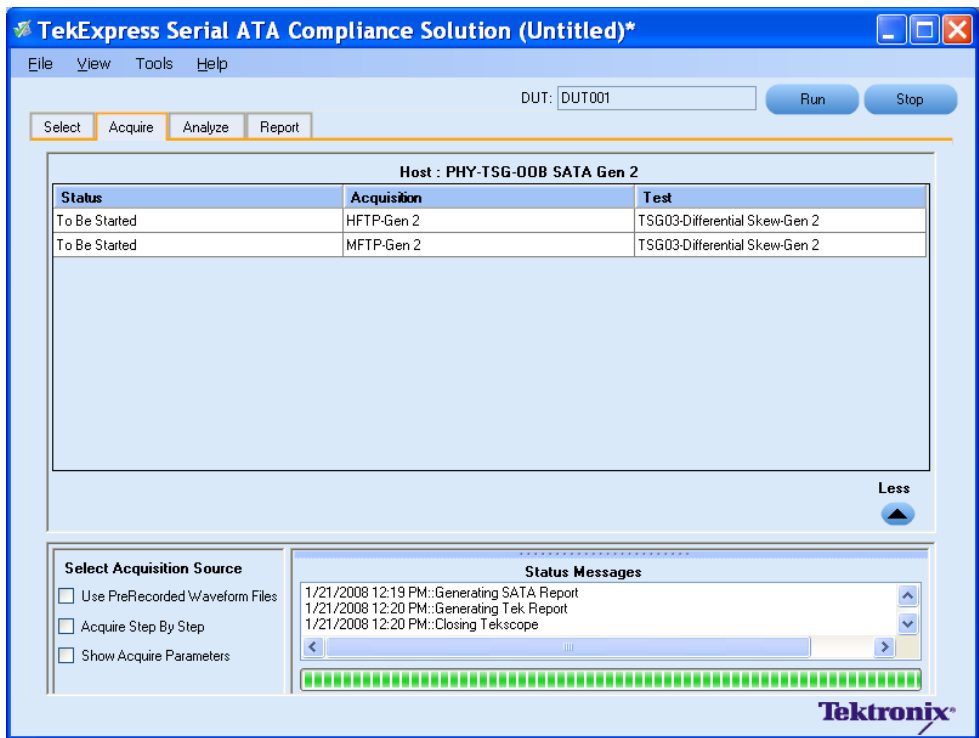

11. The status of the tests is displayed in the Analyze panel.

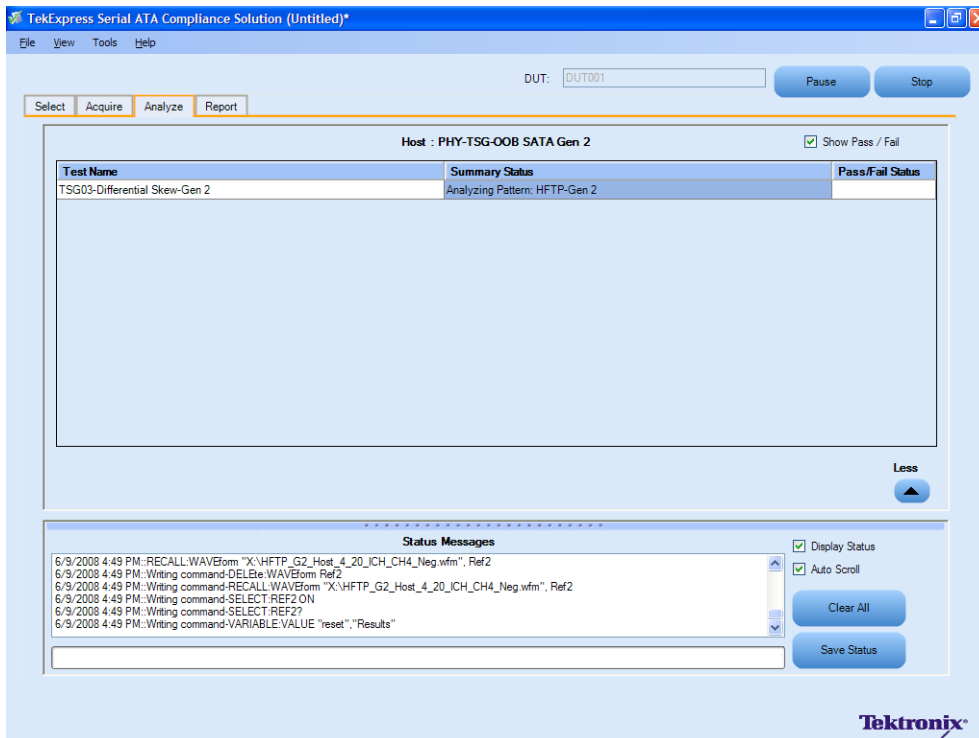

12. After the tests complete, a report is generated and displayed in the Report panel.

The screenshot shows the 'Report' panel of the TekExpress Serial ATA Compliance Solution. The window title is 'TekExpress Serial ATA Compliance Solution (screenshots)*'. The DUT is 'DUT001'. The host is 'PHY-TSG-OOB SATA Gen 2'. The report is titled 'PHY-TSG-OOB Test Report'.

Report details:

- DUT ID: DUT001
- Date/Time: 11/21/2007 14:41
- Device Type: Drive
- Overall Execution Time: 1 Min
- UUT Compliant for TSG T
- Overall Test Res: (blank)

Test Name	Test Details			Test Limits			Measured			
	Pattern Name	Interface Speed	Measurement Details	Limit1	Limit2	Limit Compare String	Units	Test result	Compliance Mode	Test Execution Time
TSG03-Differential Skew-Gen 2	HFTP-Gen 2	3.00Gbps	Differential Skew In ps	20		0.1	ps	Pass	Yes	1 Min
	MFTP-Gen 2	3.00Gbps	Differential Skew In ps	20		0.1	ps	Pass		

Configuration Parameters:

Parameter Type	Name	Value
General Parameters	ESST-L	Auto
	Initialization by Verify ESST-L	Always
Common Parameters	Mode	
	DUT Input (H/W-DUT-A)	Relay A

OOB06 - COMWAKE Gap Detection Windows Test

To verify that the COMWAKE Gap Detection Windows of the SATA Host receiver is within the conformance limits, follow these steps:

NOTE. All cables must be deskewed before performing this measurement.

1. Select **Host** as the device type.
2. Select **PHY-TSG-OOB** as the Test Suite and **SATA Gen1** as the version.
3. Enter the DUT ID in the DUT field.
4. Select the **OOB06 - COMWAKE Gap Detection Windows** option.
5. If you want to verify the test setup before running the test(s), click **Show Schematic**.

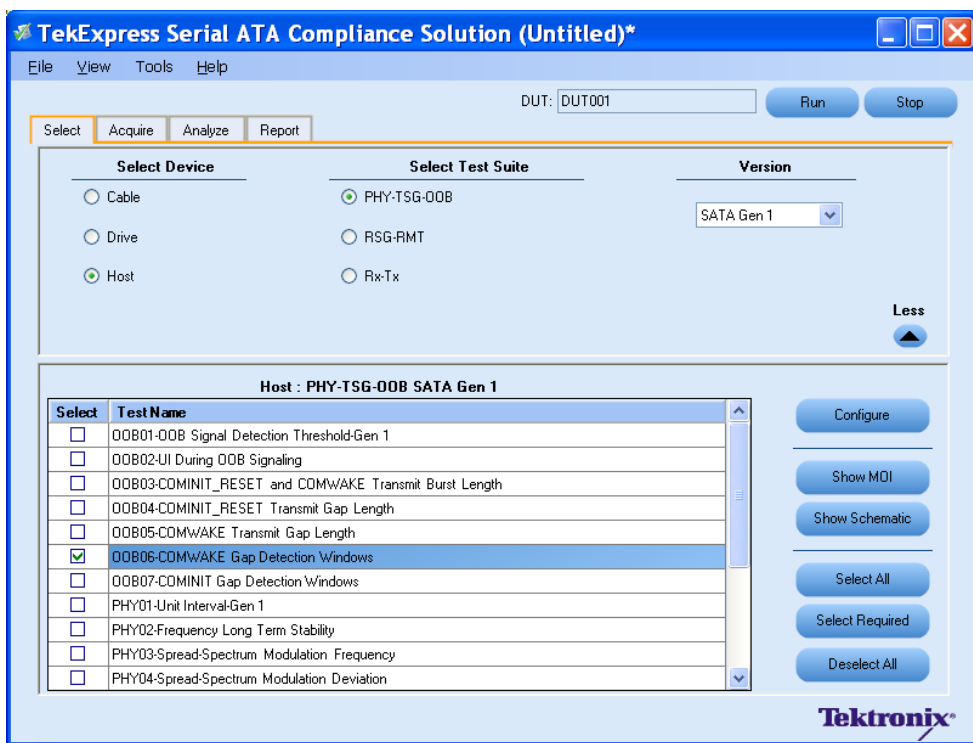

6. Click **Configure** to configure the test parameters. Observe that the default settings are in Compliance mode.
7. If you want to change the parameters, choose **User Defined Mode**. The message reports that the changes made to a test may no longer be compliant.

8. You can configure any test to help you analyze measurement results. To refer to the *Serial ATA Interoperability Program* MOI document for information on how to configure the drive receiver tests, click **Show MOI** in the Select panel.
9. Click **Apply** to apply the new settings for the selected test. If you want to restore the default settings, click **Restore**. To close the dialog box, click **Close**.

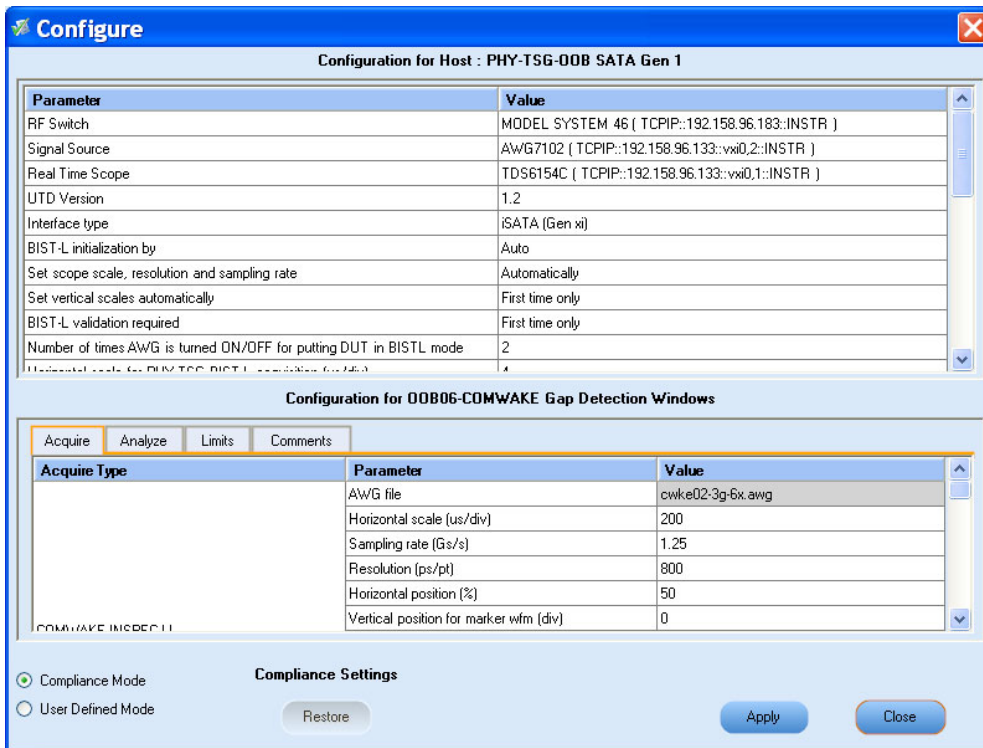

10. Click **Run** to run the selected tests.
11. The application automatically switches to the Acquire panel showing the waveform acquisition status.

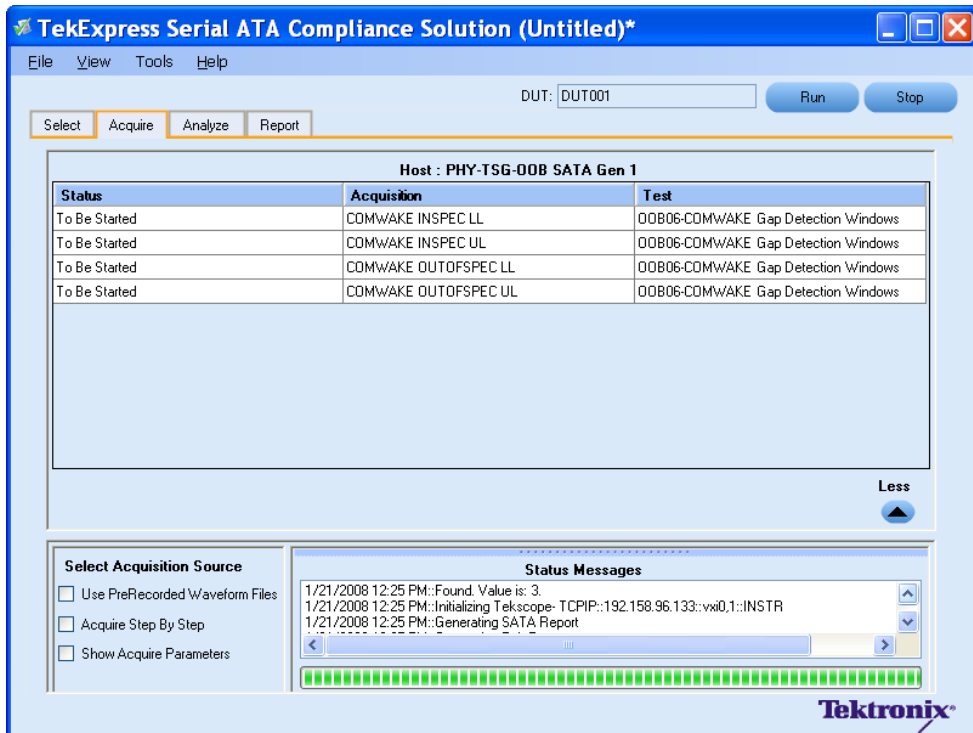

12. The status of the tests is displayed in the Analyze panel.

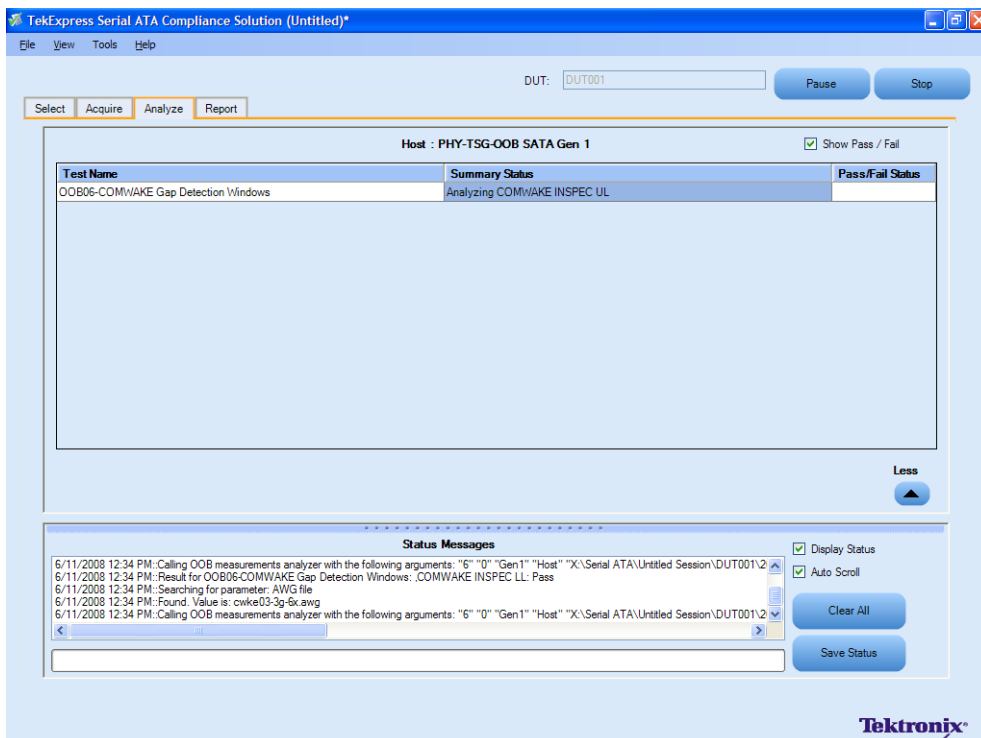

13. After the tests complete, a report is generated and displayed in the Report panel.

The screenshot shows the 'Report' panel of the TekExpress Serial ATA Compliance Solution. The report is titled 'PHY-TSG-OOB Test Report' and is for 'Host: PHY-TSG-OOB SATA Gen 1'. The DUT ID is 'DUT001' and the device type is 'Host'. The test date/time is '12/20/08 11:08'. The overall execution time is '1 Min'. The report is compliant for TSG 1.

Test Name	Test Details			Test Limits			Measured	Units	Test result	Compliance Mode	Test Execution Time
	Pattern Name	Interface Speed	Measurement Details	Limit1	Limit2	Limit Compare String					
OOB6-COMWAKE Gap Detection Windows	COMWAKE INSPEC LL	1.50Gbps		0	0EQ		0	NA	Pass	Yes	1 Min
	COMWAKE INSPEC UL	1.50Gbps		0	0EQ		0		Pass		
	COMWAKE OUTOFSPEC LL	1.50Gbps		0	0EQ		0		Pass		
	COMWAKE OUTOFSPEC UL	1.50Gbps		0	0EQ		0		Pass		

Configuration Parameters

General Parameters		
Parameter Type	Name	Value
Parameter Name	Host	PHY-TSG-OOB SATA Gen 1

Rx-Tx Equipment Setup: Drive

Resource	Model Supported
Signal Source	Tektronix AWG7102 (Option 6)
Sampling Oscilloscope	<ul style="list-style-type: none"> ■ Tektronix CSA/TDS/DSA 8200 with two 80E04 modules
RF Switch	Keithley S46-6666A
Test Fixture	Crescent Heart Software Fixture TF-SATA-NE-ZP
SMA Cables	<ul style="list-style-type: none"> ■ Five pair of matched SMA Cables – 179-4944-00 or equivalent ■ One SMA cable to connect to trigger input ■ One SMA barrel adapter
Attenuators	Four 6 dB attenuators
DUT	A SATA Drive to test

Connect the equipment as shown in the following diagram:

Setup diagram for Drive RXTX test suite

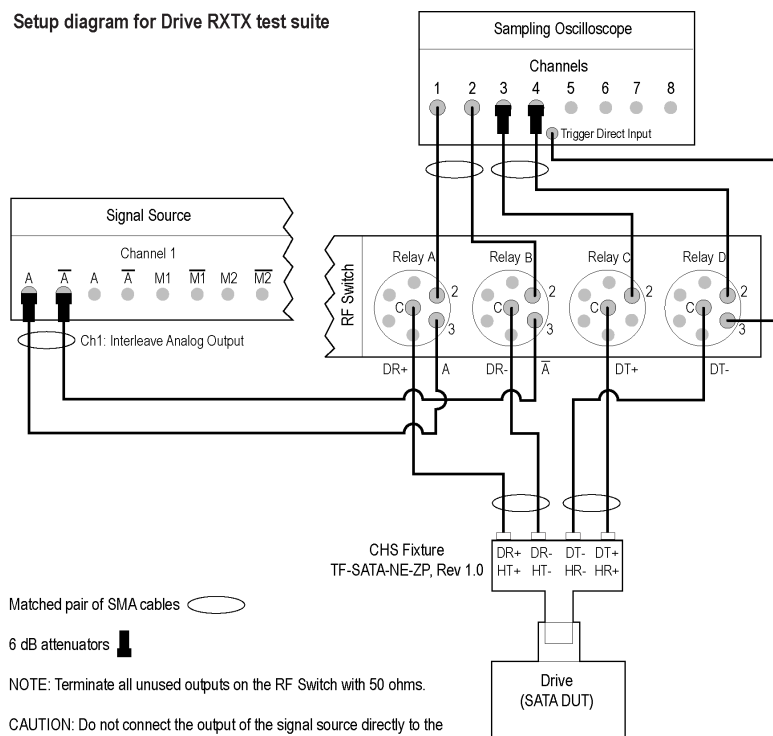

The CHS fixture notations in the schematic are with reference to Rev 1.0 of the fixture. If you are using fixtures before Rev 1.0, the fixture notations are in reverse order. For example, DT+/HR+ should be read as DR+/HT+.

If DUT Power Cycle sequence is automated using DC output of Signal Source, then do the following:
 -Connect Channel-1 of DC output to pin #14 (and pin #15 to GND) in case of 20 pin Molex connector of AT/ATX power supply.
 -Connect Channel-1 of DC output to pin #16 (and pin #17 to GND) in case of 24 pin Molex connector of AT/ATX power supply.

Rx01 - Pair Differential Impedance test

To verify that the Pair Differential Impedance of the SATA Drive receiver is within the conformance limits, follow these steps:

NOTE. This test is applicable for both Drive and Host devices. The test procedure is the same for both drive and host except for a change in the connection diagram. Refer to [Figure 5](#) for Host connection diagrams.

1. Select **Drive** as the device type.
2. Select **RX-TX** as the Test Suite and SATA Gen 1 as the version.
3. Enter the DUT ID in the DUT field.
4. If you want to verify the test setup before running the test(s), click **Show Schematic**.
5. Select the **Rx-01 – Pair Differential Impedance** option.

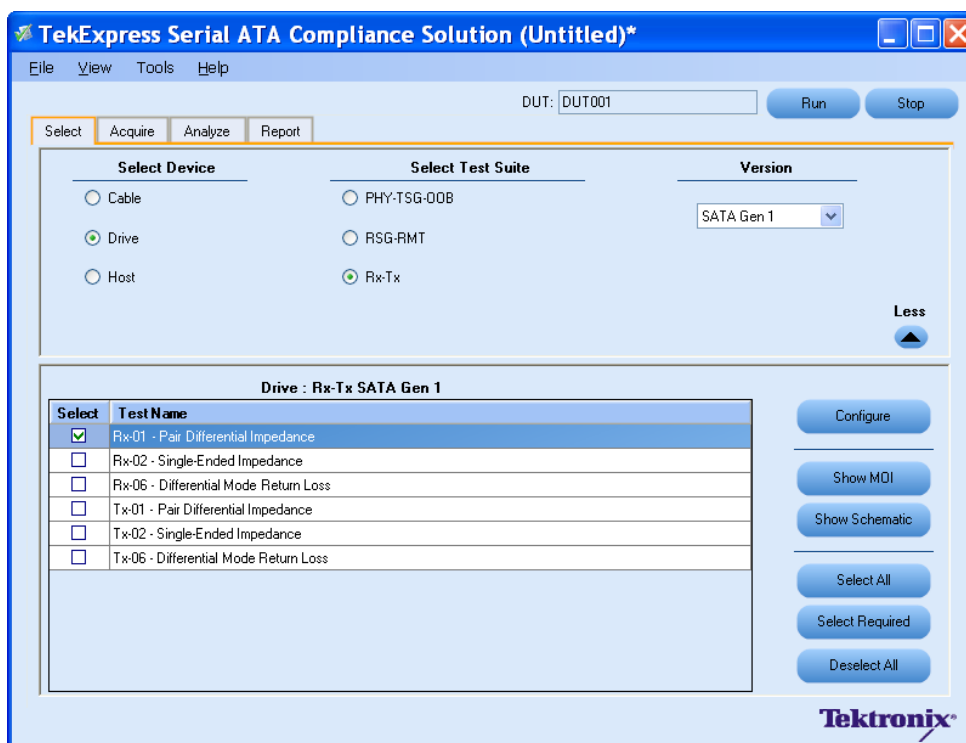

6. Click **Configure** to configure the test parameters. Observe that the default settings are in Compliance mode.

NOTE. The parameters that are not grayed are editable. To change the instrument related values, select from the drop-down list for each of the parameters.

7. You can configure any test to help you analyze measurement results. To refer to the *Serial ATA Interoperability Program* document for information on how to configure the drive receiver tests, click **Show MOI** in the Select panel.
8. Click **Apply** to apply the new settings for the test selected. If you want to restore the default settings, click **Restore**. To close the dialog box, click **Close**.

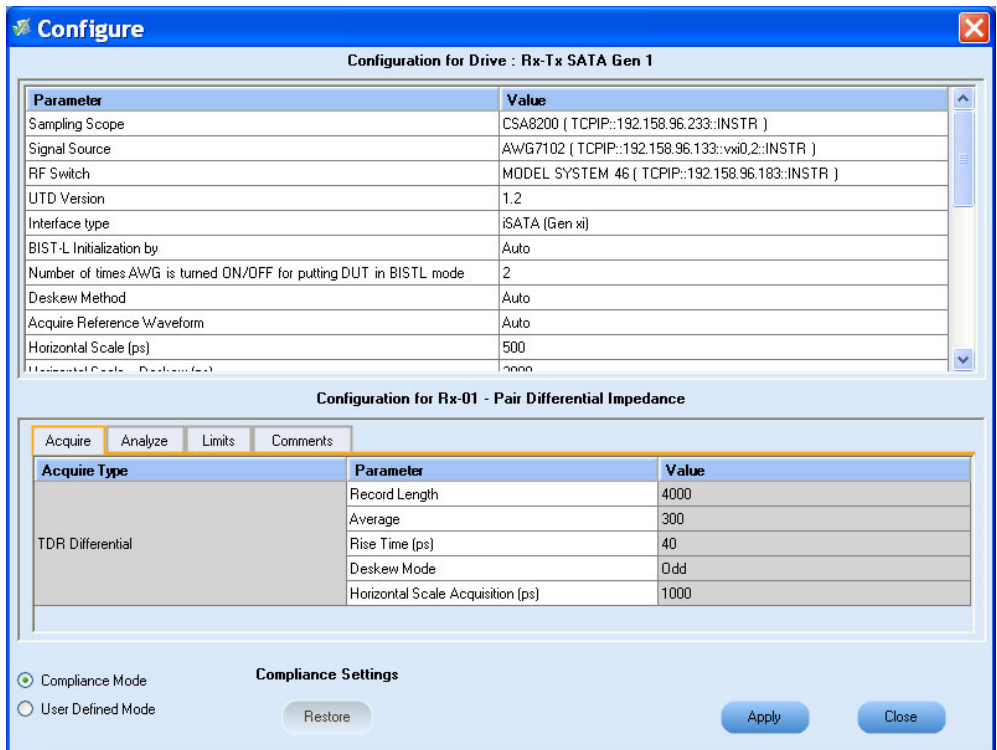

9. Click **Run** to run the selected tests.
10. The Acquire panel shows the waveform acquisition status.

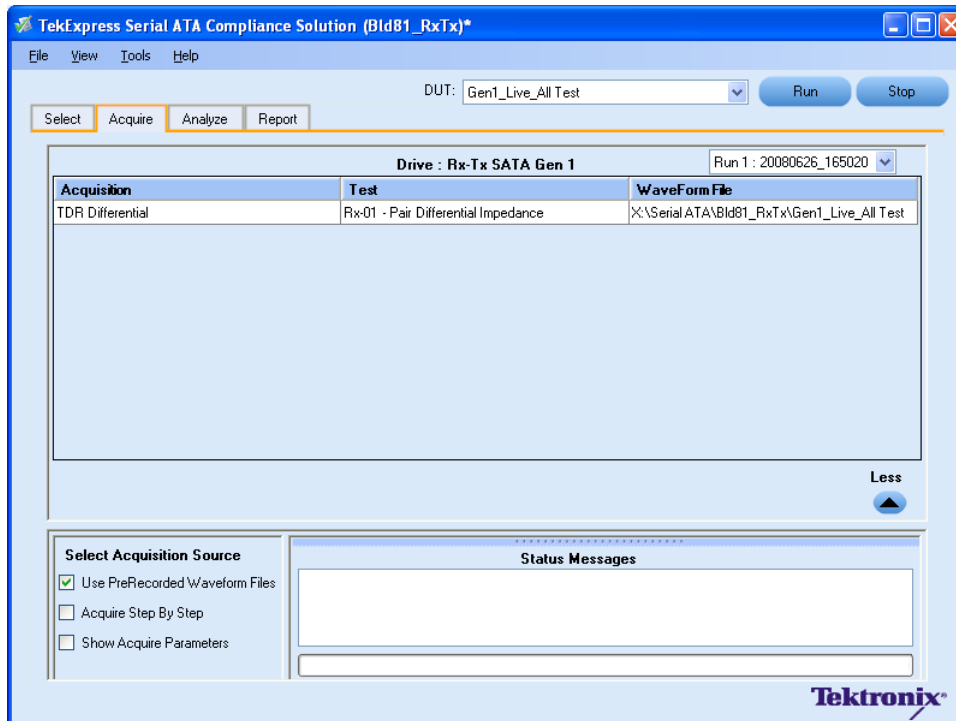

11. The status of the tests is displayed in the Analyze panel.

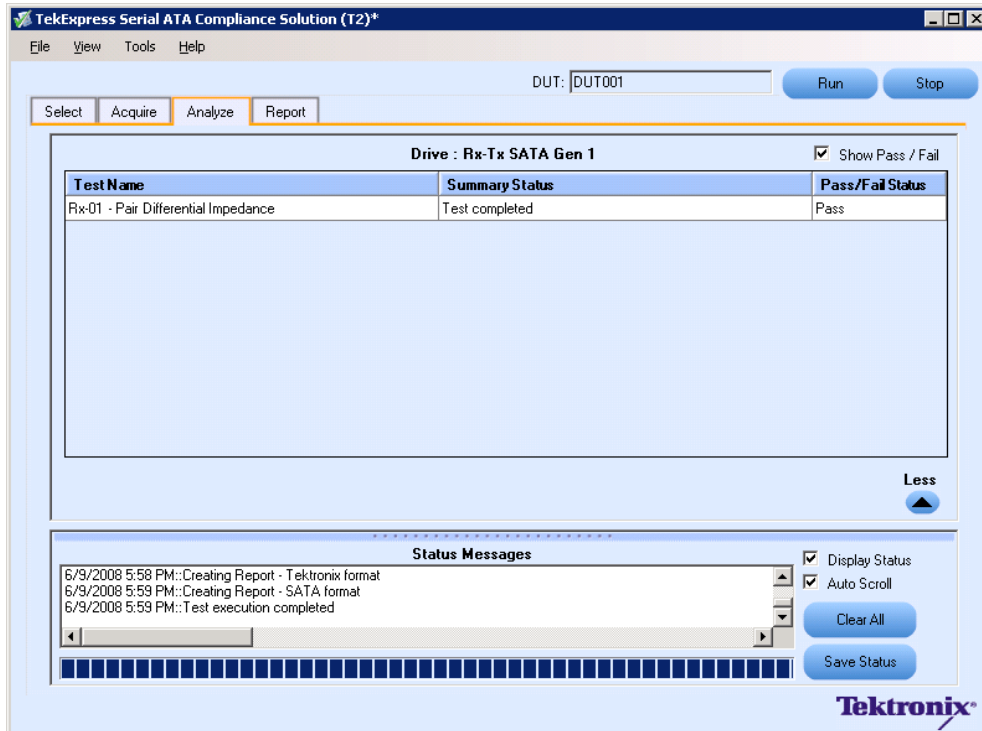

12. After the tests complete, a report is generated and displayed in the Report panel.

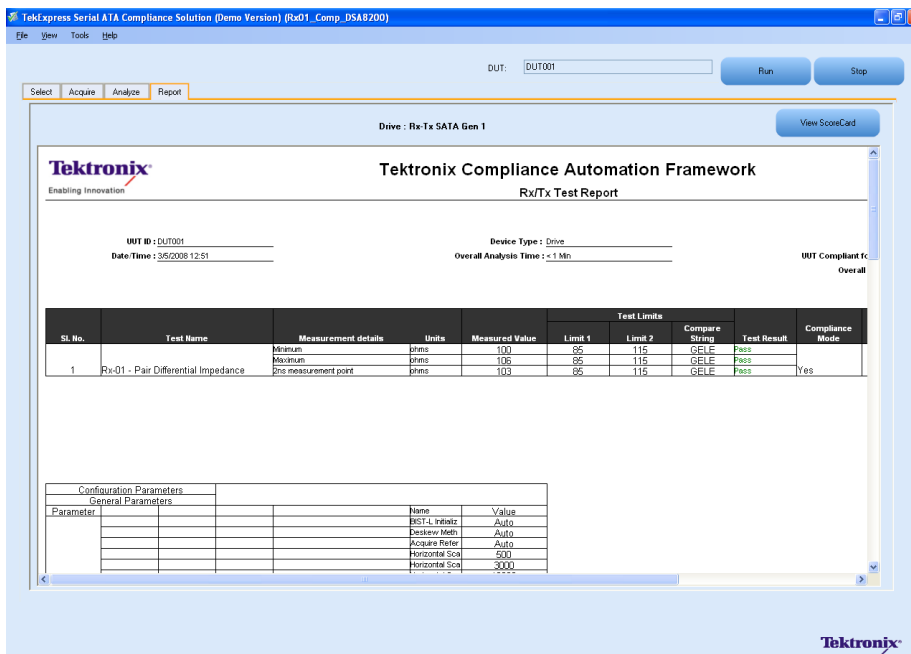

Tx02 - Single-Ended Impedance test

To verify that the Single-Ended Impedance of the SATA Drive transmitter is within the conformance limits, follow these steps:

1. Select **Drive** as the device type.
2. Select **RX-TX** as the Test Suite and **SATA Gen 1** as the version.
3. Enter the DUT ID in the DUT field.
4. If you want to verify the test setup before running the test(s), click **Show Schematic**.
5. Select the **Tx-02 Single-Ended Impedance** option.

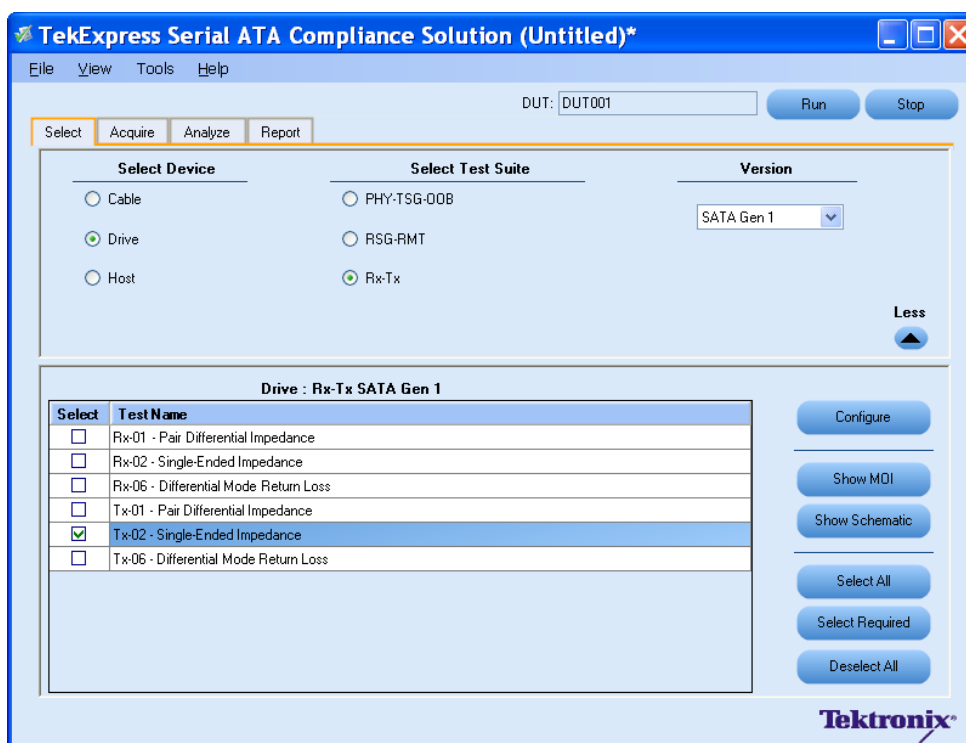

6. Click **Configure** to configure the test parameters. Observe that the default settings are in Compliance mode.

NOTE. The parameters that are not grayed are editable. To change the instrument related values, select from the drop-down list for each of the parameters.

7. You can configure any test to help you analyze measurement results. To refer to the *Serial ATA Interoperability Program* MOI document for information on how to configure the drive transmitter tests, click **Show MOI** in the Select panel.

- Click **Apply** to apply the new settings for the selected test. If you want to restore the default settings, click **Restore**. To close the dialog box, click **Close**.

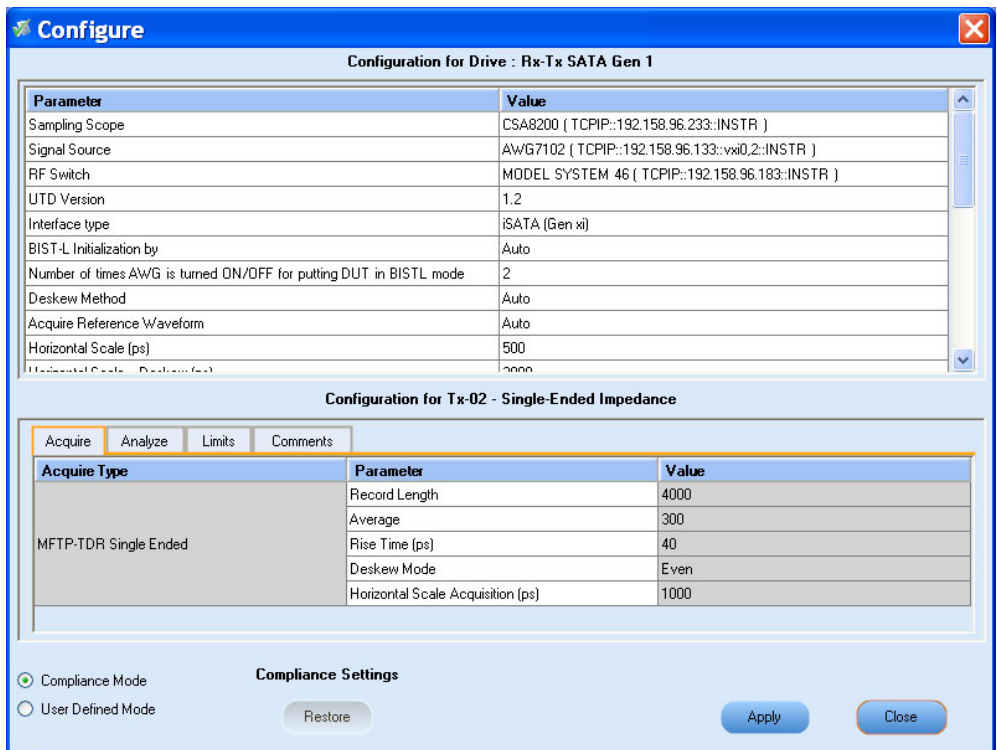

- Click **Run** to run the selected tests.

- The application automatically switches to the Acquire panel. The waveform acquisition status is displayed in this panel.

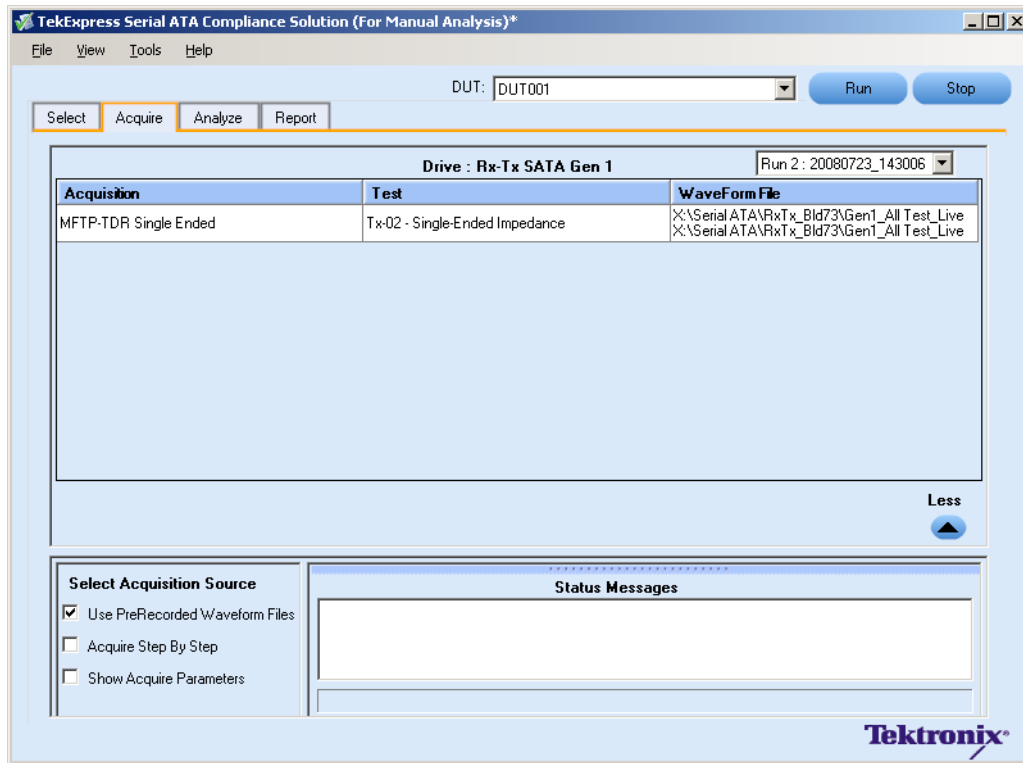

- The status of the tests is displayed in the Analyze panel.

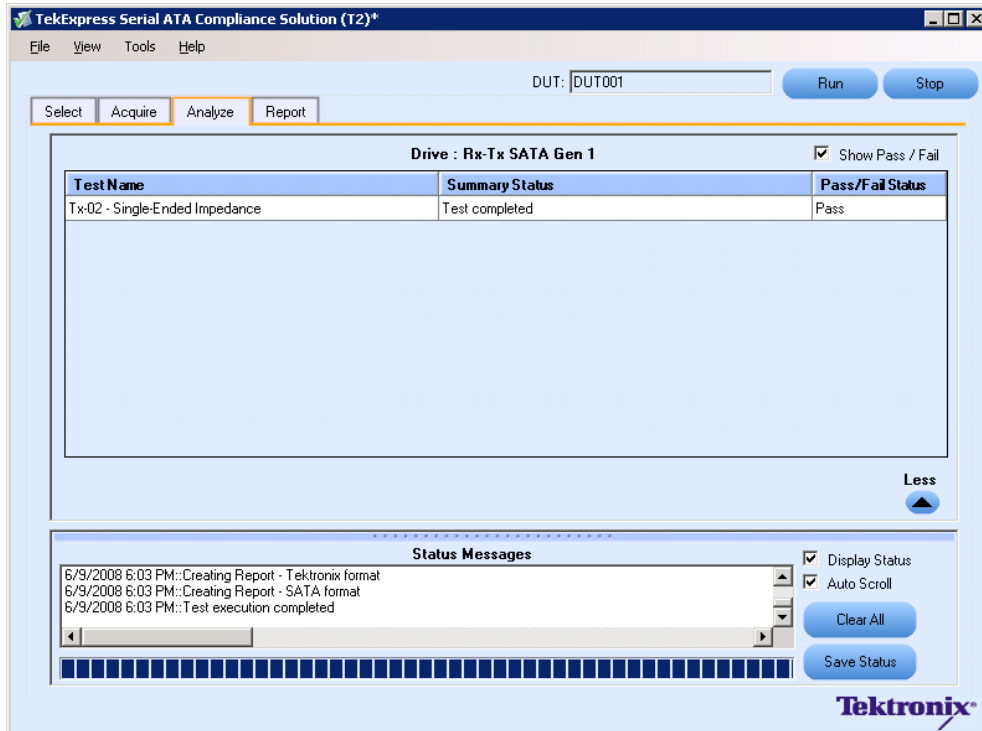

12. After the tests complete, a report is generated and displayed in the Report panel.

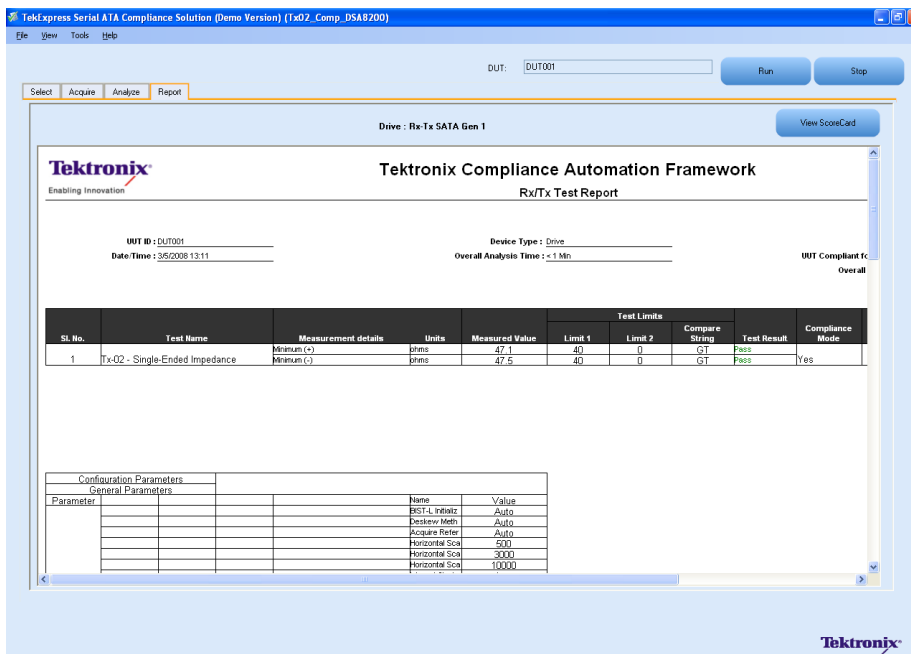

You can save the report using **File > Save Report As** option.

Rx-Tx Equipment Setup: Host

Resource	Model Supported
Signal Source	Tektronix AWG7102 (Option 6)
Sampling Oscilloscope	■ Tektronix CSA/DSA/TDS 8200 with two 80E04 modules
RF Switch	Keithley S46-6666A
Test Fixture	Crescent Heart Software Fixture TF-SATA-NE-ZP
SMA Cables	■ Five pair of matched SMA Cables – 179-4944-00 or equivalent ■ One SMA cable to connect to trigger input ■ One SMA barrel adapter
Attenuators	Two 6 dB attenuators
DUT	A SATA Host to test

Connect the equipments as shown in the following diagram:

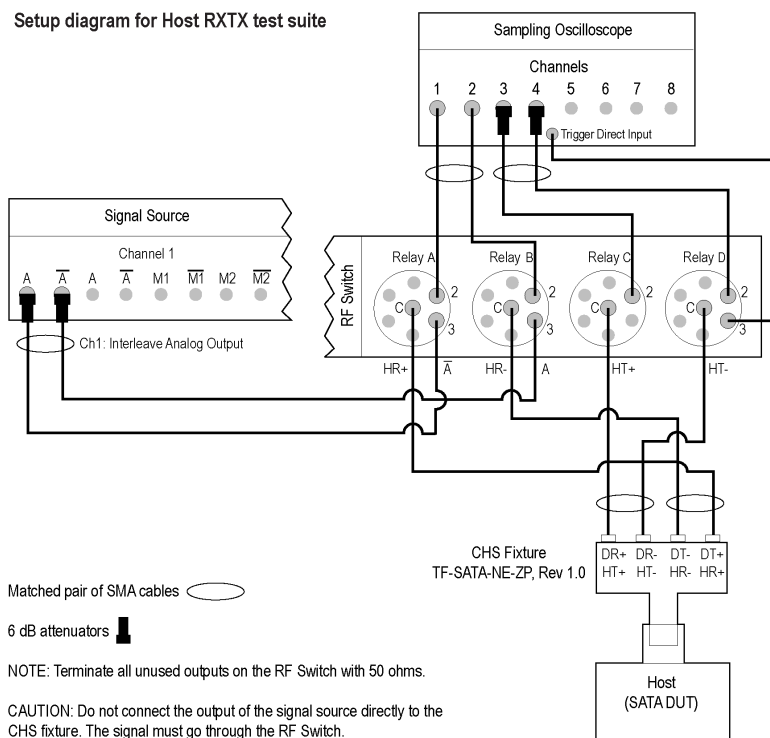

Rx03 - Differential Mode Return Loss

To verify that the Differential Mode Return Loss of the SATA Host receiver is within the conformance limits, follow these steps:

NOTE. This test is applicable for both Drive and Host devices. The test procedure is identical for both drive and host except for a change in the connection diagram. Refer to [Figure 6](#) for Drive connection diagrams.

1. Select **Host** as the device type.
2. Select **RX-TX** as the Test Suite and SATA Gen 2 as the version.
3. Enter the DUT ID in the DUT field.
4. If you want to verify the test setup before running the test(s), click **Show Schematic**.
5. Select **Rx03 - Differential Mode Return Loss** option.

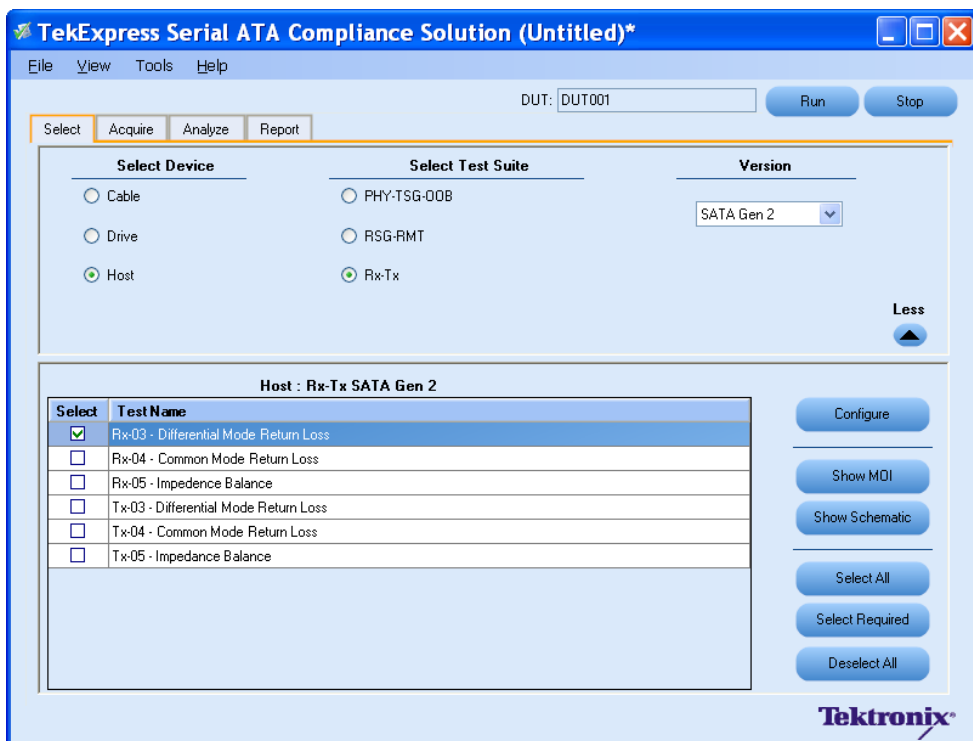

6. Click **Configure** to configure the test parameters. Observe that the default settings are in Compliance mode.
7. If you want to change the parameters, choose **User Defined Mode**. The message reports that the changes made to a test may no longer be compliant.

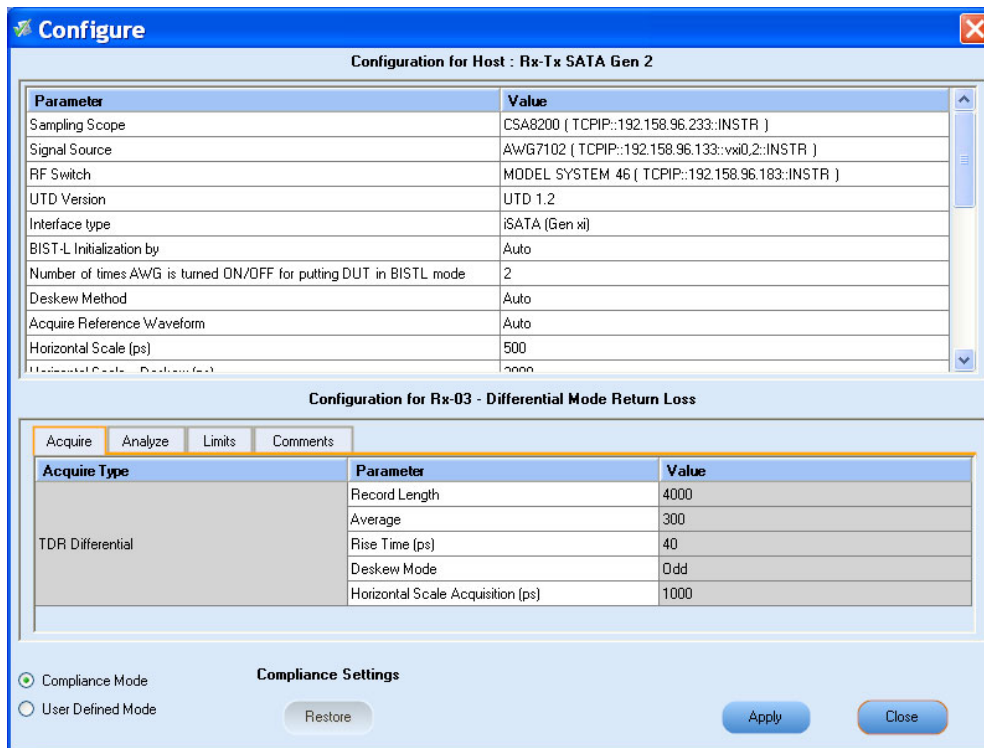

8. You can configure any test to help you analyze measurement results. To refer to the *Serial ATA Interoperability Program* MOI document for information on how to configure the host receiver tests, click **Show MOI** in the Select panel.
9. Click **Apply** to apply the new settings for the test selected. If you want to restore the default settings, click **Restore**. To close the dialog box, click **Close**.
10. Click **Run** to run the selected tests.
11. The application automatically switches to the Acquire panel. The status of the waveform acquisition is displayed in this panel.

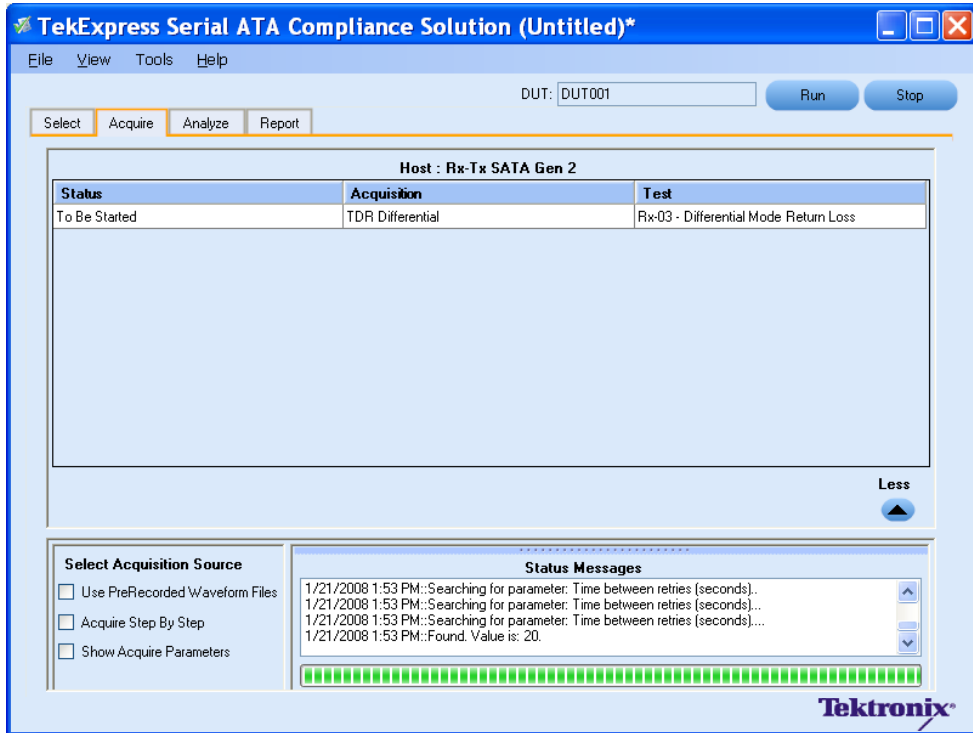

12. The status of the tests is displayed in the Analyze panel.

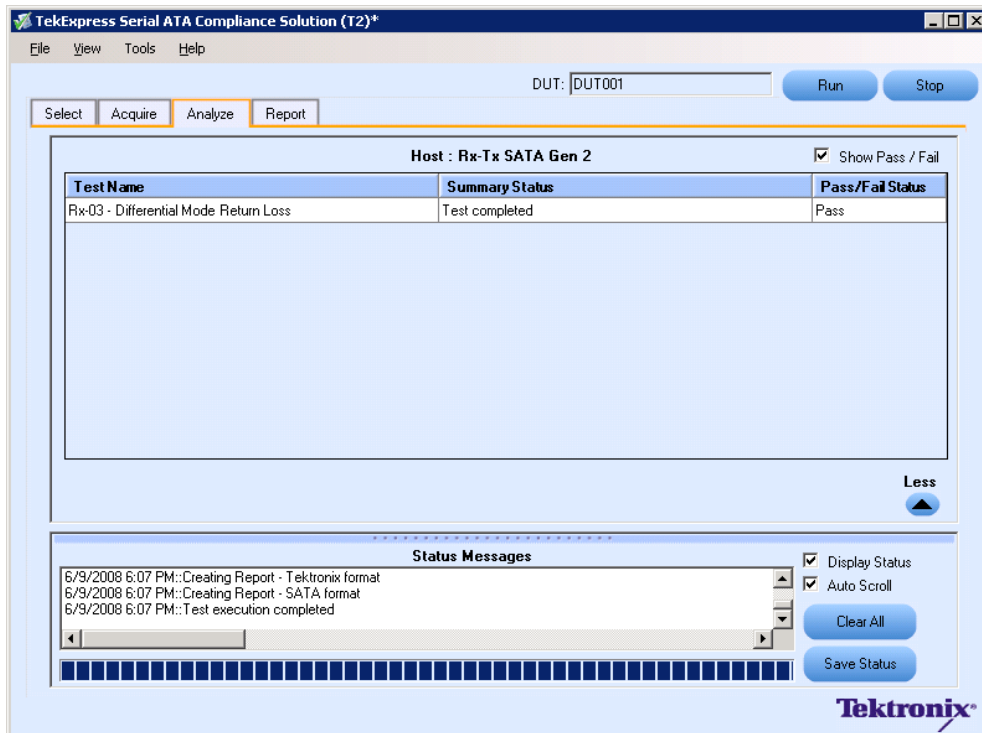

13. After the tests complete, a report is generated and displayed in the Report panel.

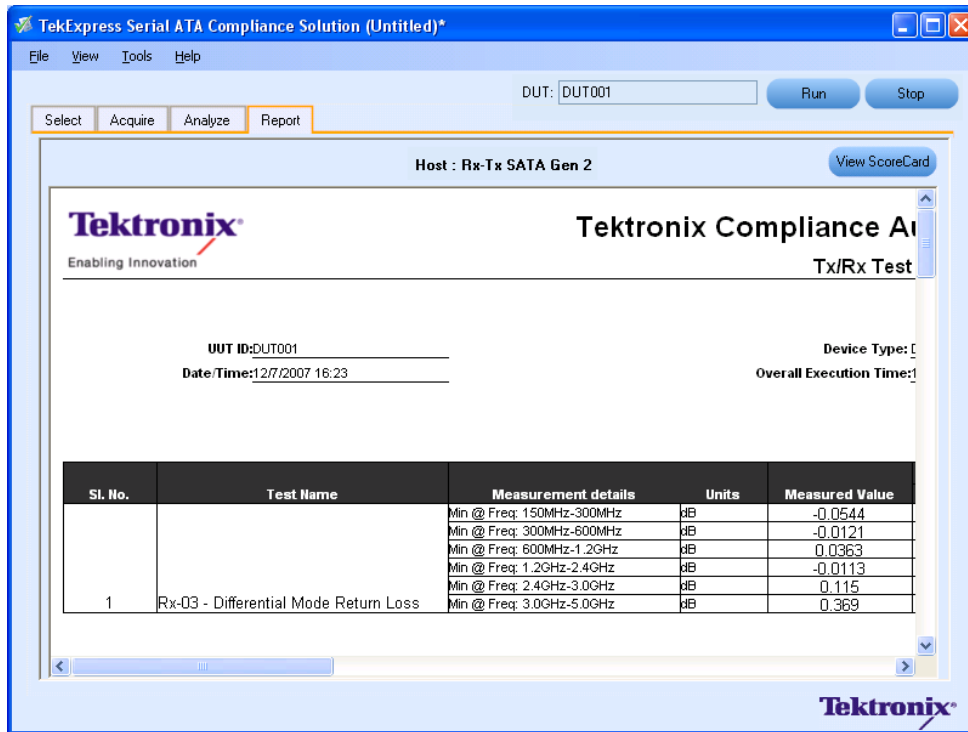

You can save the report using **File > Save Report As** option.

SI Equipment Setup

Resource	Model Supported
Sampling Oscilloscope	■ Tektronix CSA/DSA/TDS 8200 with four 80E04 modules
Test Fixture	Two Crescent Heart Software Fixture TF-SATA-FE-ZP
SMA Cables	■ Four pairs of matched SMA Cables 179-4944-01 or equivalent ■ Two SMA barrel adapters
DUT	A SATA Cable to test

Connect the equipment as shown in the following diagram:

Setup diagram for Cable SI test suite

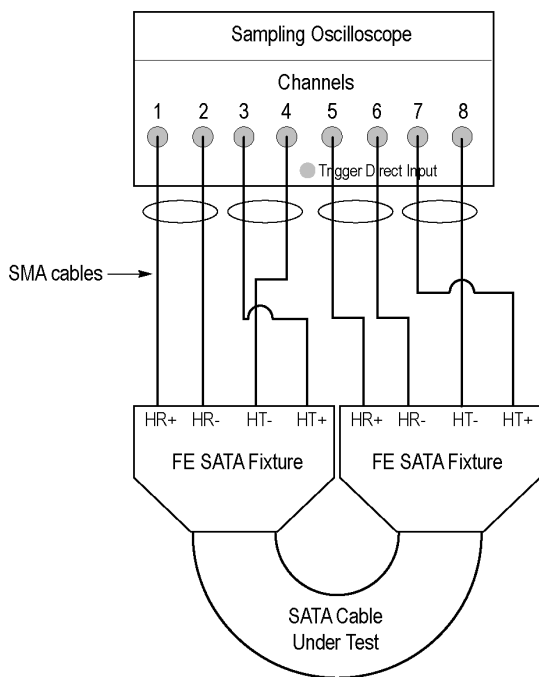

Connect the fixtures using the SATA cable.

Matched pair of SMA cables 

SI-02 - Cable Absolute Differential Impedance test on a SATA Cable

To run an SI test on a SATA Cable to conformance standards defined by SATA-IO Interoperability, follow these steps:

NOTE. This test is applicable only for SATA cables.

1. Select **Cable** as the device type.
2. Select **SI** as the Test Suite.

NOTE. There will be no test suite version for an SI test.

3. Enter the DUT ID in the DUT field.
4. If you want to verify the test setup before running the test(s), click **Show Schematic**.
5. Select a **SI-02 – Cable Absolute Differential Impedance** option.

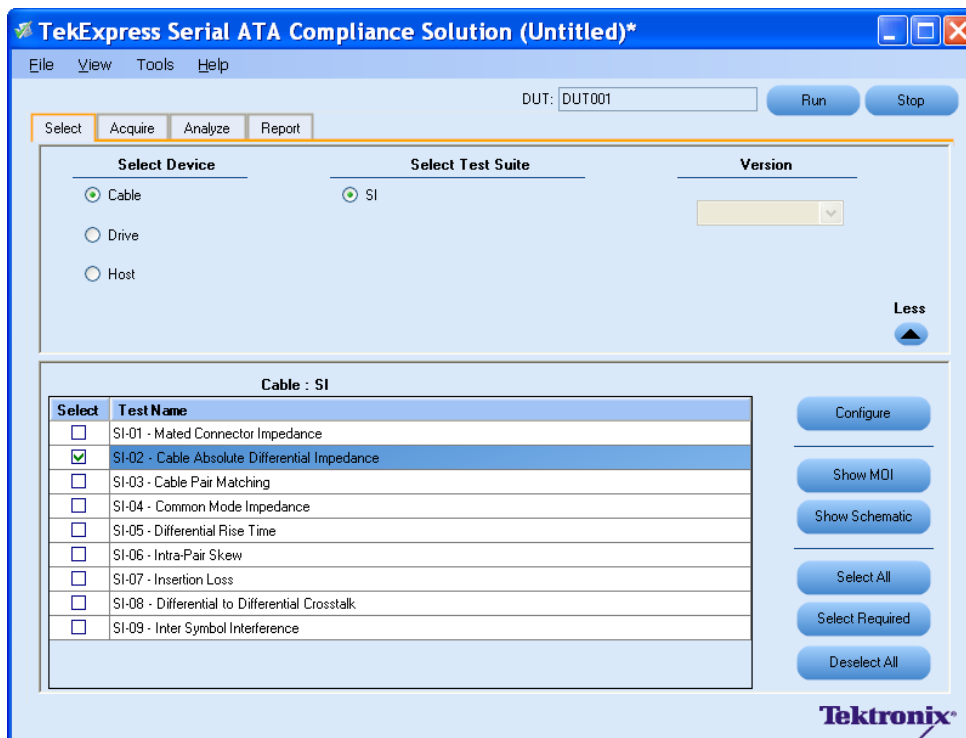

6. Click **Configure** to configure the test parameters. Observe that the default settings are in Compliance mode.

- If you want to change the parameters, choose **User Defined Mode**. The message reports that the changes made to a test may no longer be compliant.

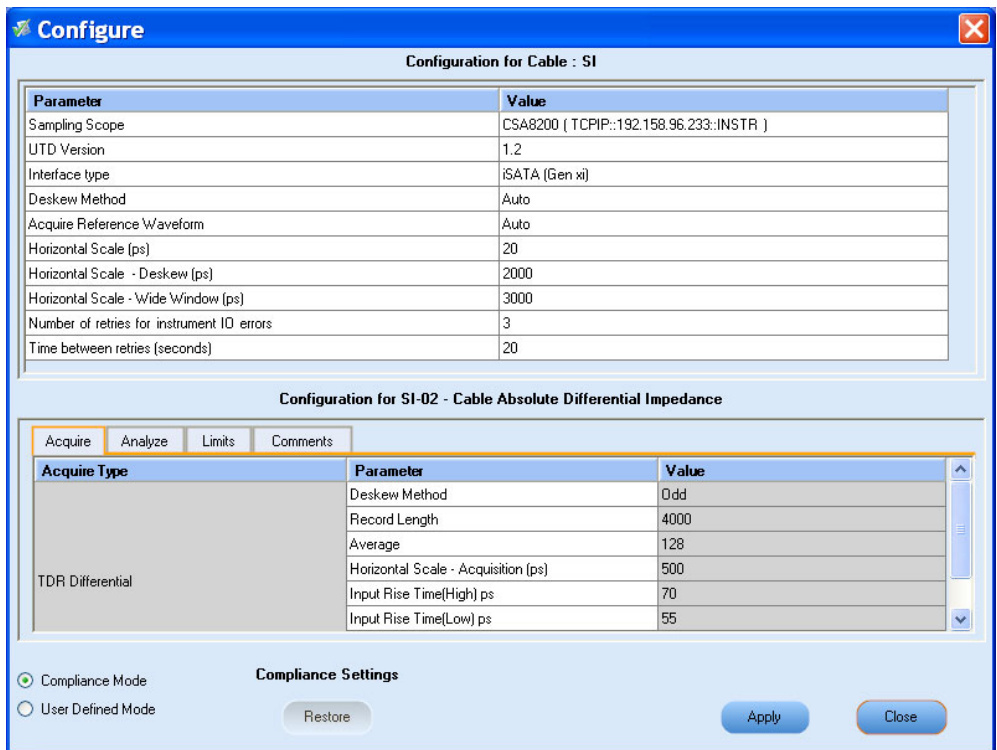

- You can configure any test to help you analyze measurement results. To refer to the *Serial ATA Interoperability Program* MOI document for information on how to configure the cable tests, click **Show MOI** in the Select panel.
- Click **Apply** to apply the new settings for the test selected. If you want to restore the default settings, click **Restore**. To close the dialog box, click **Close**.
- Click **Run** to run the selected tests.

11. The application automatically switches to the Acquire panel. This shows the status of the waveform acquisition.

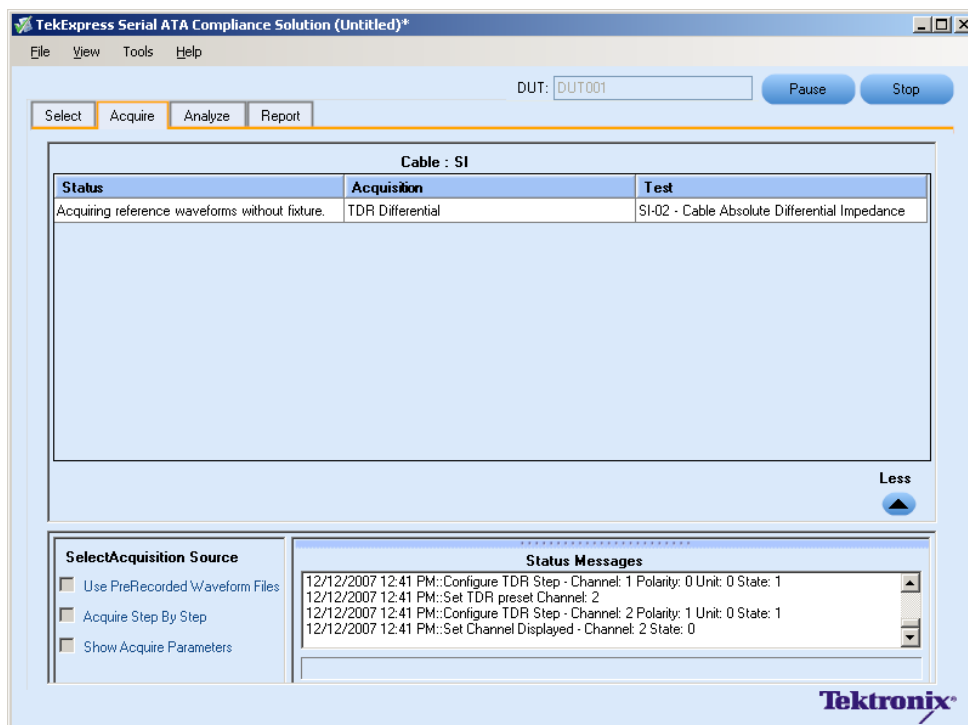

12. On completion of the acquisition, the application switches to the Analyze panel. This panel shows the status of the analysis.

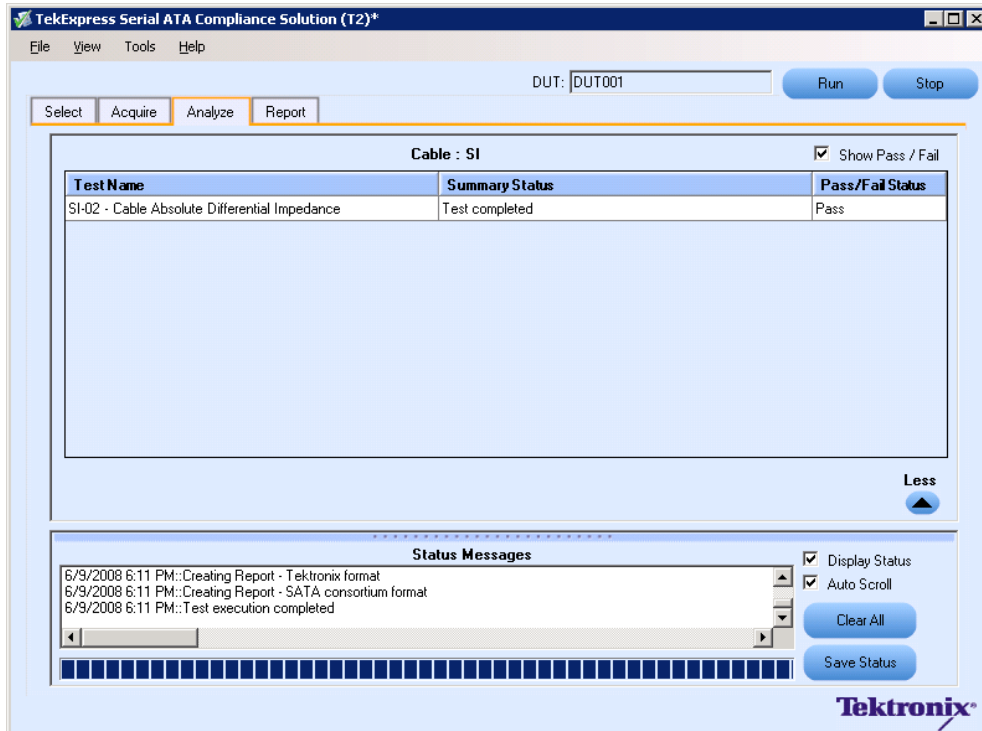

13. After the tests run successfully, a report is generated and displayed in the Report panel.

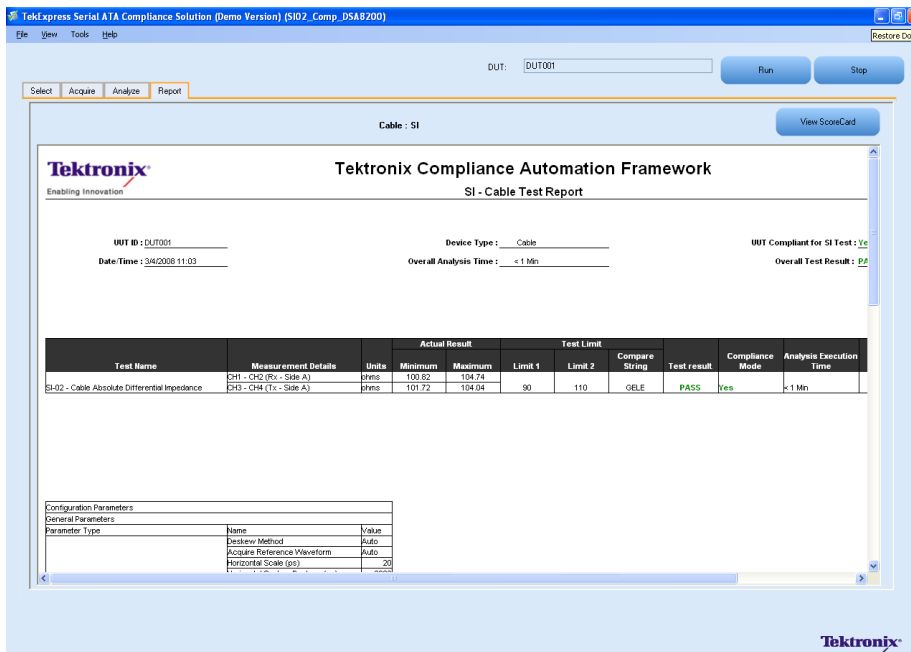

You can save the report using the **File > Save Report As** option.

Deskewing Real Time Oscilloscopes

Related Topics

[Manual Deskew Procedure for Sampling Oscilloscopes](#)

The following procedure is used for deskewing direct input SMA channels on a real time oscilloscope.

NOTE. *This deskew method is applicable for RSG-RMT and PHY-TSG-OOB test suites.*

1. Run Signal Path Compensation (SPC) on the oscilloscope.
2. Connect a SMA Power Splitter (preferred) or SMA 50 ohm coaxial “T” connector to the Fast Edge output of the oscilloscope.
3. Connect SMA cables from each of the two channels to be deskewed to the power splitter (or SMA coaxial “T” connector). It is best to use matched cables when making high speed serial measurements. **It is important to use the same cables that will be used for subsequent measurements.**
4. Select **Default Setup**, and then select **Autoset** on the oscilloscope front panel.
5. Set the oscilloscope for 70% to 90% full screen amplitude on both channels. Center both traces so that they overlap.
6. Make sure that volts/div, position, and offset are identical for the two channels being deskewed.
7. Set the time/div to approximately 100 ps/div or less, with sample rate at 1 ps/pt. These settings are not critical, but should be close.
8. Set the horizontal acquisition mode to average, which provides a more stable display.
9. Select **Deskew** from the **Vertical** menu.
10. Verify that the reference channel (typically CH1 or CH2) is set to 0 ps deskew.
11. In the deskew control window, select the channel to deskew (typically CH3 or CH4). Adjust the deskew to overlay the rising edge as best as possible.

NOTE. *Typical values are in the 10's of ps or less with cables connected directly from Fast Edge to SMA inputs. If you are using a switch box (for example, Keithley), deskew the complete path from where the test fixture connects, through the switch, and into the oscilloscope. Deskew values in these cases may be as much as 30 ps or more.*

There are sometimes significant differences in the skew between two TCA-SMA adapters. If you find that a system requires a very large correction, it might be better to find a pair of TCA-SMA adapters that match each other better.

Manual Deskew Procedure for Sampling Oscilloscopes

Mixed Mode TDR Channel Alignment with Independent TDR Source

This deskew procedure uses an independent acquisition source and assumes availability of two TDR sampling modules (80E04, 80E08, or 80E10). You can also deskew with one TDR (80E04, 80E08, or 80E10), and one dual sampling module (80E03 or 80E09). It aligns both samplers and TDR steps allowing you to measure mixed mode S-parameters. The procedure starts with the alignment of the samplers and concludes with alignment of the acquisition channels.

The following equipment is required:

- One sampling oscilloscope mainframe (TDS8000, TDS/CSA/DSA8200).
- Two TDR sampling modules (80E04, 80E08, or 80E10).
- Four matched SMA cables.
- One SMA barrel (female-to-female) adaptor. Click [here](#) to view the picture.



Equipment required to perform mixed mode deskew procedure. The wrist strap is important for ESD protection and a calibrated torque wrench is recommended to protect the connectors and to get good repeatability.

Click the links below to get details on them.

Align the acquisition channels to the ends of the cables.

The purpose of this step is to set the samplers on each channel so that an input into the open end of each cable arrives at the sample gate at precisely the same time. This step compensates for cable and sampler differences. CH1 through CH3 are aligned using CH4 as an independent TDR source. Then, CH4 is aligned with respect to CH3 using CH1 as the independent source. The following deskew procedure is to be performed in [rho mode](#).

The “rho” can be selected from the TDR menu of the Setups dialog. Follow the below steps to get to the rho mode:

1. Select the **Setups** menu from the Oscilloscope main menu.
2. Click the **TDR** tab.
3. Select ρ option from the drop-down list.

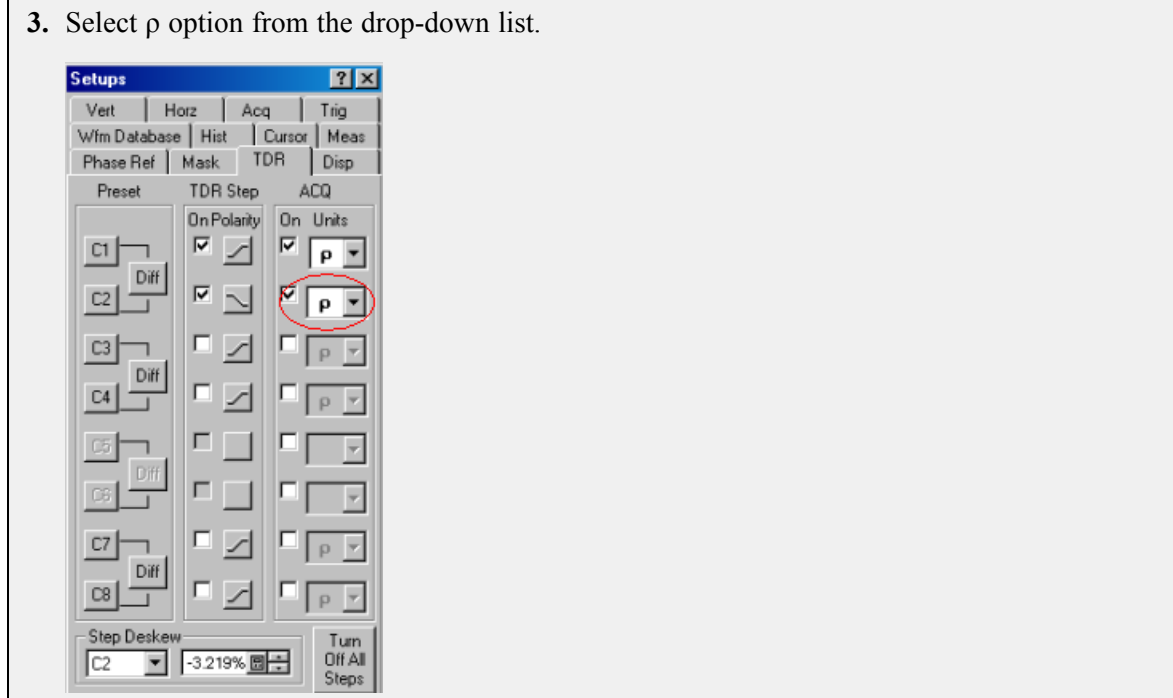

1. Connect SMA cables to the sampling modules of the oscilloscope. For the best results, ensure that the SMA cables used in the measurements have approximately the same quality and length (matched within 20 ps).
2. Connect channel 1 and channel 4 with SMA barrel, activate TDR step on channel 4 and acquire using channel. Click [here](#) to see the figure.

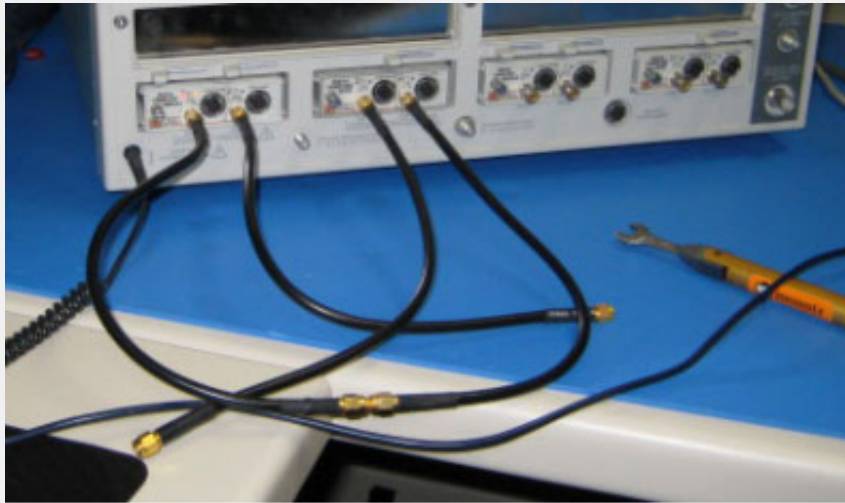

CH1 is connected to CH4 with an SMA barrel. The TDR step is generated on CH4 and acquired using CH1.

3. Adjust the horizontal position and scale to get the rising edge on screen with good resolution (20 ps/div). Record length should have a maximum of 4000 points.
4. Save channel one (CH1) waveform as a reference trace. CH2 and CH3 will be aligned with respect to it.
5. Connect CH2 to the CH4 using SMA barrel, and display CH2 on the screen.
6. Turn on the delay measurement to measure the time difference between the rising edge on the reference trace and the rising edge of CH2 as shown [here](#).

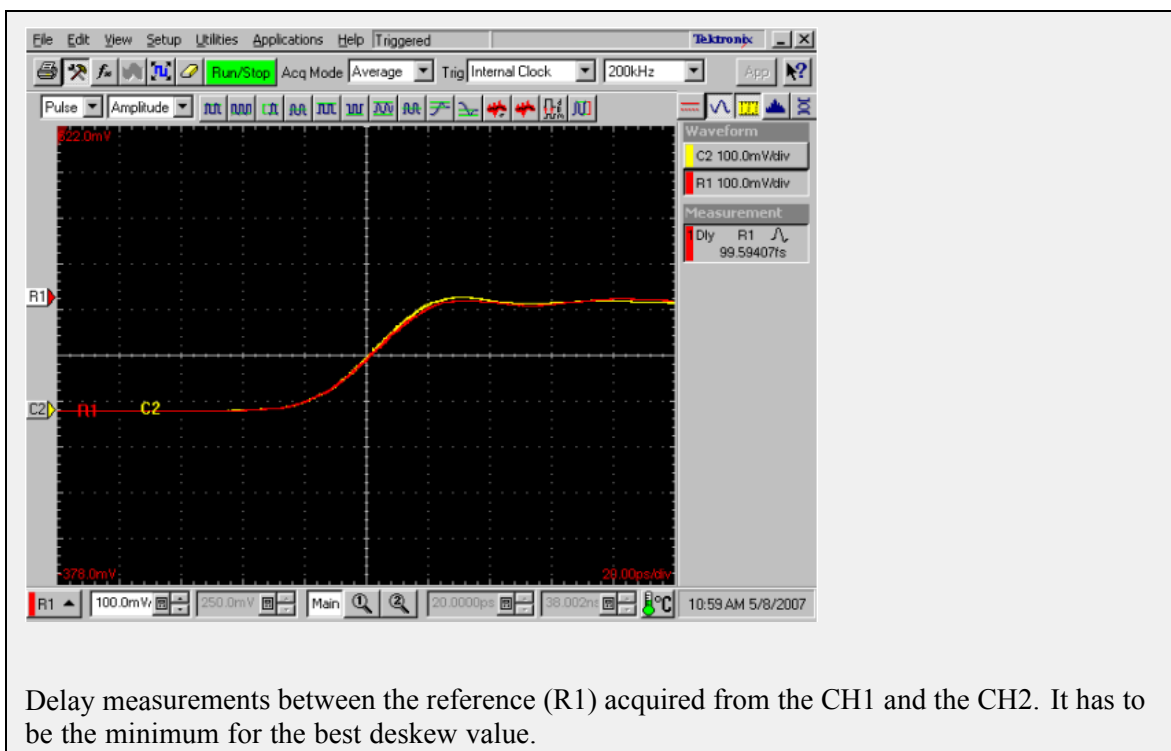

7. Adjust the channel deskew value in the Vertical menu of the Setups dialog box until a delay value within 1 ps is achieved.
8. Repeat step 5 through step 7 for the CH3.
9. Once the acquisition of CH1 through CH3 is aligned, use the same method to align CH4. Generate a new reference by using the step of CH1 and acquiring it on CH3. Connect CH3 to CH1 with the SMA barrel.
10. Repeat step 5 through step 7 for CH4 using the acquired reference from CH3.

Now, all four acquisition channels have been deskewed within 1 ps.

Match TDR step generators.

The purpose of this step is to adjust the TDR pulses so that they arrive at the ends of the cables at precisely the same time. The deskew has to be performed separately for odd and even TDR steps when 80E04 modules are used. This section describes only odd mode TDR step deskew. The following deskew procedure has to be performed in *rho* mode:

1. Disconnect the SMA barrel and turn on TDR pulses of the appropriate polarity for each channel (CH1 and CH2). Use the differential TDR preset selection to activate odd mode.
2. Adjust the horizontal position and scale so that the pulses are visible on the screen as they arrive at the ends of the cables. (Use the Average mode and vectored display, and set the time scale to 20 ps/div).
3. Turn on the delay measurement to measure the time difference between the two pulse edges.
4. Adjust the *Step Deskew* in the TDR menu to minimize the time difference between the CH1 and CH2 pulses. You might want to use the **Fine** button to reduce the increment of deskew as shown [here](#).

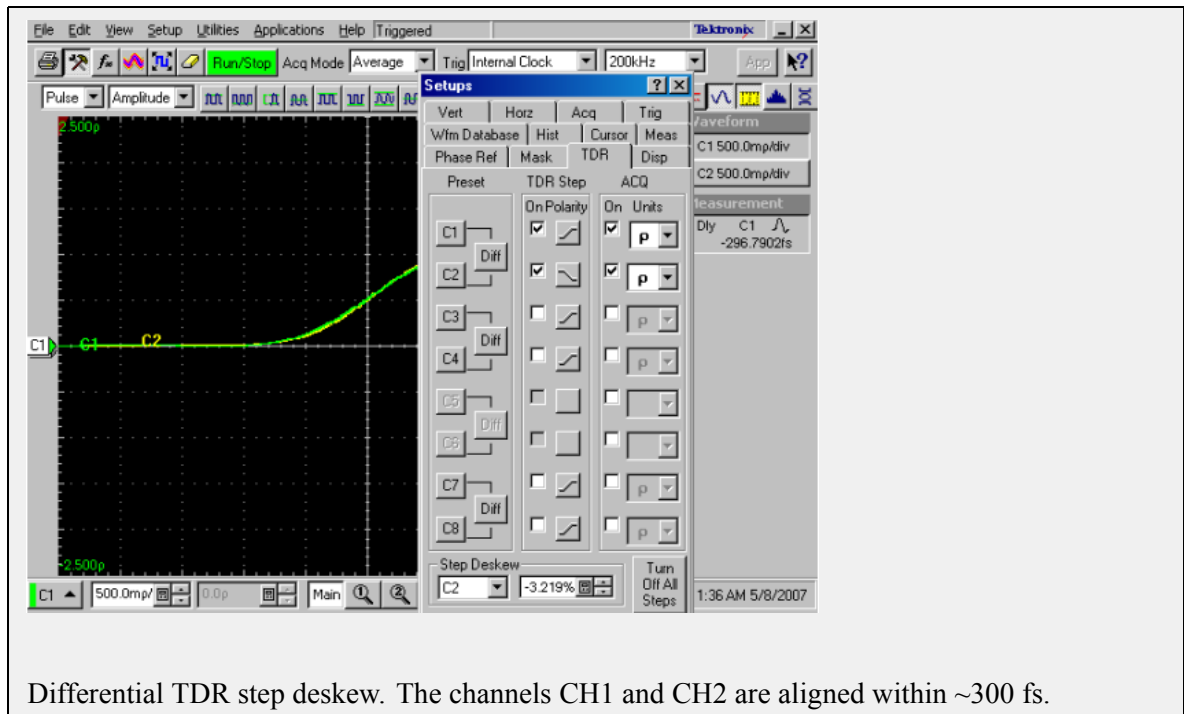

5. Repeat step 1 through step 4 for CH3 and CH4, and save the instrument setup.
6. Repeat step 1 through step 5 in even mode if desired.

The instrument should now be set up to accurately make differential or common mode TDR measurements.

Sampling Oscilloscope Deskew during RXTX Testing for Test Setup without RF Switch

When performing RXTX tests with test setup without RF switch it is essential to use long cables (~6 ft. or more) from AWG channels connected to the power-splitter connection on CH1 and CH2 of sampling oscilloscope to avoid the reflection from AWG channels. On similar lines it is also essential to use long cables from “External Trigger” of sampling oscilloscope connected to the power-splitter connection on CH4.

You can verify if there is a reflection from AWG channels during test execution process. The waveform captured on CH1 during deskew operation might look as follows. The highlighted area is reflection from AWG channels.



Along with using long cable you may be required to adjust horizontal scale properties from “Config” panel of the application to remove the reflection outside the capture window. Optimal settings horizontal scale properties for RXTX are described below:

- Horizontal Scale (ps): 50
- Horizontal Scale - Deskew (ps): 1000
- Horizontal Scale - wide window (ps): 3000

With use of 6 ft long cable and above parameters following is example correct waveform captured on CH1 during deskew, notice that there is no visible reflection captured in the window.



About Overriding Acquire Parameters

This section is applicable for test suites that require a real time oscilloscope (for example, test suites like PHY-TSG-OOB or RSG-RMT). The TekExpress application supports various oscilloscope models for SATA compliance testing and not all the oscilloscope models can support the same acquire parameters (combination of record length, horizontal scale and resolution). For such test suites, TekExpress allows you to either “Automatically” apply correct acquire parameters settings or manually specify them. (This option is available in the “Configure” panel of corresponding test suite with the option name “Set oscilloscope scale, resolution and sampling rate”). When “automatically” is selected, the application ignores the acquire parameters you specified. If you need to specify your own acquire parameters, then you must specify the name “Set oscilloscope scale, resolution and sampling rate” option to “Manually” in the “Configure” panel of the corresponding test suite.

Acquire parameters with “Automatically” option

This option will be applicable for the following oscilloscope models only. If any other oscilloscope model is found, the application will automatically use the parameters that you specified while executing the test sequence.

- Supported TDS models: TDS6154C, TDS6124C, and TDS6804B
- Supported DPO/DSA models: DPO/DSA70804, DPO/DSA71254, DPO/DSA71604, and DPO/DSA72004

For supported oscilloscope models, the following acquire parameters are applied automatically during test sequence execution depending on the type of acquisition.

Acquisition Type	TDS6154C, TDS6124C, TDS6804B			DPO/DSA70804, DPO/DSA71254, DPO/DSA71604, DPO/DSA72004		
	Scale (μ s/div)	Resolution (ps/pt)	Sampling rate (Gs/s)	Scale (μ s/div)	Resolution (ps/pt)	Sampling rate
BISTL validation for RSG/RMT	10	25		10	20	
BISTL validation for PHY/TSG	4	25		4	20	
Initial OOB validation	2	100	10	2	80	12.5
HFTP*	40	25		40	40	
HFTP-Gen 1	10	50		10	40	
HFTP-Gen 2	4	25		4	20	
LBP-Gen 1	10	50		10	40	
LBP-Gen 2	4	25		4	20	
LFTP-Gen 1	10	50		10	40	
LFTP-Gen 2	4	25		4	20	

Acquisition Type	TDS6154C, TDS6124C, TDS6804B			DPO/DSA70804, DPO/DSA71254, DPO/DSA71604, DPO/DSA72004		
	Scale (µs/div)	Resolution (ps/pt)	Sampling rate (Gs/s)	Scale (µs/div)	Resolution (ps/pt)	Sampling rate
MFTP-Gen 1	10	50		10	40	
MFTP-Gen 2	4	25		4	20	
COMINIT and COMWAKE	10	50	20	10	40	25
COMINIT INSPEC LL	200	800	1.25	200	800	1.25
COMINIT INSPEC UL	200	800	1.25	200	800	1.25
COMINIT INSPEC UL	200	800	1.25	200	800	1.25
COMINIT OUTOFSPEC LL	200	800	1.25	200	800	1.25
COMINIT OUTOFSPEC UL	200	800	1.25	200	800	1.25
CO-MINIT/COMRE-SET/COMWAKE-No response	200	800	1.25	200	800	1.25
CO-MINIT/COMRE-SET/COMWAKE-Response	200	800	1.25	200	800	1.25
COMWAKE INSPEC LL	200	800	1.25	200	800	1.25
COMWAKE OUTOFSPEC LL	200	800	1.25	200	800	1.25
COMWAKE OUTOFSPEC UL	200	800	1.25	200	800	1.25
COMRESET	4	50	20	4	40	25

Acquisition Type	TDS6154C, TDS6124C, TDS6804B			DPO/DSA70804, DPO/DSA71254, DPO/DSA71604, DPO/DSA72004		
	Scale (μ s/div)	Resolution (ps/pt)	Sampling rate (Gs/s)	Scale (μ s/div)	Resolution (ps/pt)	Sampling rate
COMWAKE	10	50	20	10	40	25

* Long record length for Gen1 SSC and Gen2 SSC

Acquire Parameters with “Manually” Option

It is important that you carefully specify the correct combination of horizontal scale and resolution depending on the oscilloscope model. If an incorrect combination of horizontal scale and resolution is specified, then the test execution sequence is terminated, displaying incorrect parameter set status message.

An example of status message is as shown:

```
10/3/2007 10:29 AM::Writing command-HORIZONTAL:RECO 2500000
```

```
10/3/2007 10:29 AM::Set record length to-2000000
```

The following procedure describes how to manually identify a working combination of horizontal scale, resolution and record length for a given oscilloscope:

1. Open the Talker Listener utility of the TekVISA on the oscilloscope.
2. Apply default settings on the oscilloscope by clicking **Default setup** on the oscilloscope panel front panel.
3. Use the oscilloscope front panel to disable CH1 and enable CH2 and CH4.
4. In the Talker Listener utility, enter `HORI:RECO <record length>` (for example, `HORI:RECO 2000000`) and click **Write**.
5. Verify that the oscilloscope has applied the record length that you specified in step 4. If yes, continue with step 6 else repeat steps 2 through 4 with another record length.
6. In the Talker Listener utility, enter `HORI:SCALE <horizontal scale>` (for example, `HORI:SCALE 10E-06`) and click **Write**.
7. Verify that the oscilloscope has applied the horizontal scale that you specified in step 6 and also verify that the record length set in step 4 is not changed. If this condition is met, then you have identified a working combination of Acquire parameters. If this condition is not met, then repeat steps 2 through 6 with another combination of Acquire parameters.

The above step will help identify the correct combination of horizontal scale and record length. To find combination of horizontal scale and resolution, follow the preceding procedure and find the resolution using the following mathematical expression.

$$\text{Resolution} = (10 * \text{horizontal scale}) / \text{Record length}$$

Using the Pattern Generation Utility to Test Receivers

Related Topics

[Calibration Procedure](#)

The Pattern Generation is a utility that generates a controlled jittered waveform for performing the RSG (Receiver Signal Gain) and RMT (Receiver Margin Testing) testing for the DUT receiver. This utility uses a direct synthesis approach where required amounts of jitter components are added to the frame composite. These patterns are injected to DUT using the Arbitrary Waveform Generator 7000 series with option 6, Test fixture and matched pair cables.

Use the Calibration process (as outlined in the RSG MOI, section APPENDIX C - Measurement Calibration) to calibrate and obtain the calibrated values of Random Jitter, Periodic Jitter, ISI jitter, amplitude level, (optimal amplitude value of) jittered frequency (which is tuned to meet the nominal Total Jitter specified); use these calibrated values for the pattern generation utility.

It is recommended to do the calibration process for each pattern generation of interest.

For the RMT tests, there is a need to test the DUT over a range of frequencies. The calibration has to be carried out at these frequencies for exact results.

The pattern generation utility is located in the following folder of TekExpress install DVD:

```
<DVD Drive letter>:\SATA Setup Files\AWG Files\SataPatternGeneration Utility
```

If you have installed AWG setup files, the same utility will also be available on the AWG local hard-drive in the following folder location:

```
C:\SataPatternGenerationUtility\
```

Important Notes:

- Above folder contains Ver 3.0 of the pattern generation utility. Ver 3.0 is updated with feature to characterize ISI jitter insertion.
- The MATLAB Run-time engine 7.6 is required for executing these utility files. MATLAB Run-time engine 7.6 installer is located on TekExpress install DVD in, <DVD drive letter>:\Software\MATLAB_Runtime folder.
- The file attribute for Serial ATA pattern generation utility and associated files should NOT be “Read only”. It is noticed that upon installation from DVD the file attributes are set to “Read-only” which causes this utility to terminate prematurely.

Inputs to the Pattern Generation Utility (ver 3.0 satagen V3.exe) with ISI Jitter characterization

The Pattern Generation Utility Ver 3.0 is an Executable and requires you to input the following parameters (in this order). You need to provide the following inputs and they are not default values.

1. UTD version. The UTD version should be either 1.2 or 1.3 as input.
2. Seconds command line input parameter is the path and name of the Frame composite pattern. The available options are Gen18KRJTPAT.txt for Gen-1 interface speed and Gen21KRJTPAT.txt, Gen29KRJTPAT.txt and Gen216KRJTPAT.txt for Gen-2 interface speed. You can also specify customized text file for frame composite pattern. (For example, frame composite pattern files used

in Ver 1.0 IW4Gen1R10FCP2AnewLBP.txt for Gen1 and IW4Gen2R8FCP2AnewLBP.txt for Gen2 can also be specified).

3. The interface speed of the DUT, the input parameter should be either Gen1 or Gen2.
4. Calibrated voltage swing for the utility. This is usually calculated using the 6 db attenuators at the end of the match cables. You can refer the amplitude calibration process to measure calibrated amplitude level.
5. The calibrated Random Jitter (Rj). You can refer to the calibration procedure for more details on how to calculate the Rj value for this setup. Rj has to specified in ps RMS.
6. Periodic Jitter (Pj) component as frequency in Hz. You should specify the frequency value between 0 to 300 MHz as 'Start' and 'Stop'. The start should be less than the stop otherwise the utility shows an error.
7. The Pj increment is in steps of 1 MHz (step given as "xe6") and the higher range is 300 MHz.
8. The Total jitter (Tj specified in Unit Interval (UI)) range is 0 to 1.2 UI. You have to specify the start and stop separately as 'Start' and 'Stop' without the 'UI' unit. The start should be less than the stop otherwise the utility will show an error.
9. The Tj increment values. These values increase in the following steps as per the Serial ATA standard. The predefined steps are 0.01, 0.02, 0.03, 0.05 and 0.1.
10. The Amplitude Periodic jitter. You have to make sure that the amplitude periodic jitter used in the utility to generate pattern of interest (for example 10 MHz 0.45 UI) has to result in nominal Tj value 0.45 UI. This is done by means of trial and error by recording the Tj at the output of the JIT3 Analysis-Advanced software. Please refer to the MOI calibration procedure for more details.

The following parameters are optional in Ver 2.0 of Pattern Generation Utility; if you are not specifying these parameters then specify empty arguments ("", "").

11. Cable S-Parameter file location is the next command line input parameter. The available options are 9inISITrace.s4p, 6pt75inISITrace.s4p, 5inISITrace.s4p, 31inISITrace.s4p, 2pt42inISITrace.s4p, 24inISITrace.s4p, 17inISITrace.s4p, 12inISITrace.s4p. You can also specify customized S-Parameter file created in S4P file format.
12. The last command line input parameter is the cable effect co-efficient. This parameter is used to specify the multiplying factor for cable S-Parameter. For example, if you specify 1.6 as the cable effect co-efficient then the cable length effect would be considered as 1.6 times. This parameter value is valid only when the S-Parameter file location is specified.

Output from the Pattern Generation Utility

The generated jittered waveform is available in the Frame composite pattern file path with file name as <UTD version>_<Jitter Frequency>-MHz-TJ>UI.wfm. <Example for UTD version 1.2, Pj from 100 MHz to 105 MHz and Tj= 0.45 UI: The sample file name output format is 1.2_100-MHz-0.45UI.wfm. The five AWG patterns are generated from 100 MHz to 105 MHz.

Batch file usage

To help you get familiar with the Serial ATA Pattern Generation Utility, an example `Example_02.bat` file is provided in the same location as that of utility files.

To use the batch file example, follow these steps:

1. Double-click the `Example_02.bat` file.
2. The batch file gets launched and you can observe the input parameters on the DOS command prompt that is taken by the utility.

Calibration Procedure

Related Topics

[Using Pattern Generation Utility to Test Receivers](#)

To generate jittered waveforms for RSG test, the complete calibration procedure has to be followed. Whereas, to generate jittered patterns for RMT test, only Random jitter calibration is required. Calibration can be carried out using the JIT3 Analysis - Advanced software.

Click any of the following jitter-related measurements to see its definition:

Random Jitter Calibration

A reference Gen1 and Gen2 MFTP waveform with zero jitter (MFTP-Rj-Cal.wfm) is provided at `c:\SataPatternGenerationUtility\Gen1MFTP` folder to verify the calibration of Random jitter (Rj). Before verifying the Rj calibration, perform an SPC calibration on the Tektronix oscilloscope hosting the Advanced JIT3 Analysis software and perform a D/A channel calibration on the Arbitrary Waveform Generator (AWG) to compensate for the instrument’s environmental conditions.

Rj is specified to be 0.18 UI PtP @ 7 Sigma or 4.285 ps RMS for Gen2 signaling rates and correspondingly 8.57 ps for Gen1 signaling rates.

NOTE. The Rj found in the Tektronix AWG MFTP pattern has been digitally synthesized and is a truncated Gaussian distribution with the 4.7 Sigma crest factor.

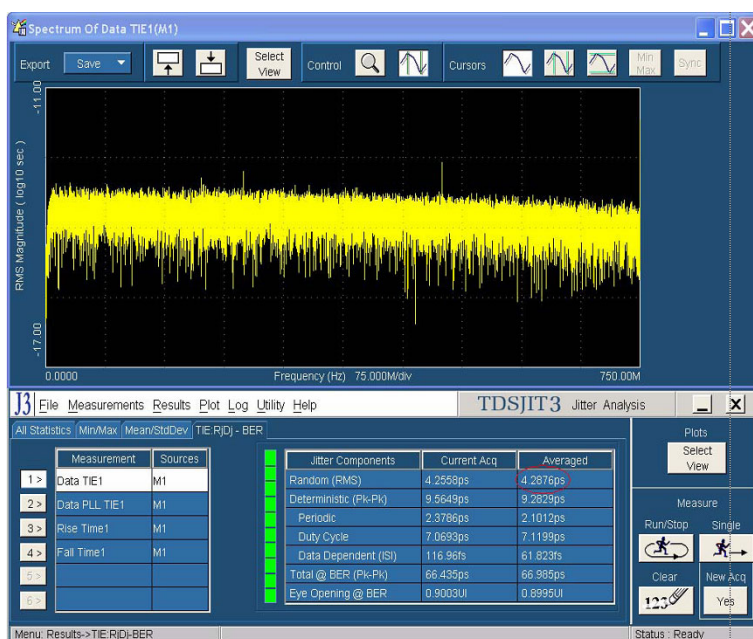

As illustrated in the red circled area of the preceding figure, ensure that the averaged RJ is nominally reading 4.285 ps RMS ± 4% allowable variation 4.11 ps < Nominal Value < 4.45 ps. Analyze 16E6 contiguous points per measurement, and 3 runs will typically converge on an averaged RJ close to 4.285 ps. For Gen1 rates the nominal variation of Rj would be within 8.22 < Nominal Tj Value < 8.9. Jitter magnitudes in excess of these values should result in recalibration of the AWG.

If the measured value in JIT3 results does not match with nominal Rj value 4.285 ps ±4% then random jitter component has to be varied as the input to the utility.

Perform this iteration until Rj value is close enough to nominal value specified.

Tj Calibration

Run the Pattern Generation utility using the IW4Gen1R10FCP2AnewLBP.txt for Gen1 and IW4Gen2R8FCP2AnewLBP.txt for Gen2 text patterns available at c:\SataPatternGenerationUtility\. With calibrated random jitter value and optimal value of the Amplitude of jittered frequency, generate a XX-MHz -0.45UI.wfm waveform. Analyze this waveform using JIT3 Advanced software.

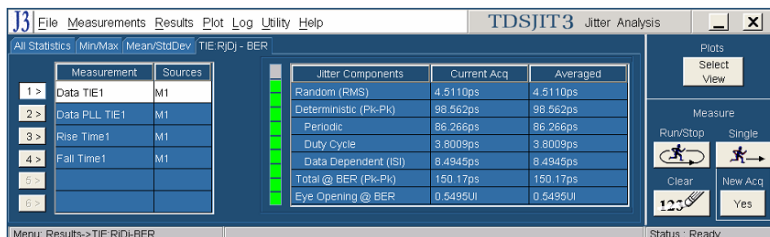

Observe the averaged Total @ BER (Pk-Pk) Jitter value after three acquisitions. Adjust the amplitude of jittered frequency value input so as to get the nominal value of Tj. The nominal accuracy of a calibrated system will provide 0.45 UI Tj conformance within 4% of nominal error. The observed jitter for Gen2 signaling Tj should nominally be 149.9 ps of Tj ± 4% allowable variation. 144 ps < Nominal Tj Value < 155.8 ps. Jitter magnitudes in excess of these values should result in recalibration of the AWG.

For Gen1 rates, the nominal variation of a nominal value of Tj would be within 288 < Nominal Tj Value < 312 ps.

If the measured value in the JIT3 results does not match with nominal Tj value 144 ps < Nominal Tj Value < 155.8 ps then vary the amplitude of the periodic jitter component as the input to the utility.

Perform this iteration until the Tj value is close enough to the nominal specified.

Amplitude Calibration

Signal amplitude conformance requires that Gen1 and Gen2 signaling not exceed 600 mV or 750 mV ptp and be within 5% of a target minimum amplitude of 325 mV and 275 mV respectively. Fine adjustment may be performed by adjusting the Vertical amplitude setting on the AWG's CH1 output. The minimum amplitude measurements are performed on both 212141 (negative pulse) and 413 (positive pulse) RL patterns.

Refer to the SATA specifications (Serial ATA Revision 2.5 27-October-2005) on LBP based amplitude measurements.

The minimum amplitude over a 1 UI epoch is the two consecutive bits at the string of a four or more consecutive bits, which is not a representative LBP pattern but is the minimum value in Framed Composite (Pre-ECN18) pattern.

A 0.45 UI to 0.55 UI Histogram is setup on the two lone bits of interest from which the difference of the mean values is computed to obtain the lone pulse amplitudes.

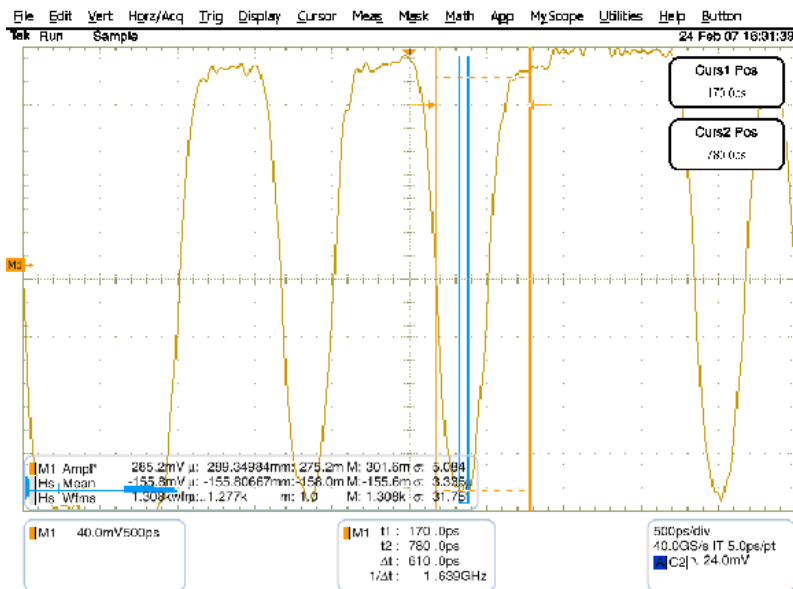
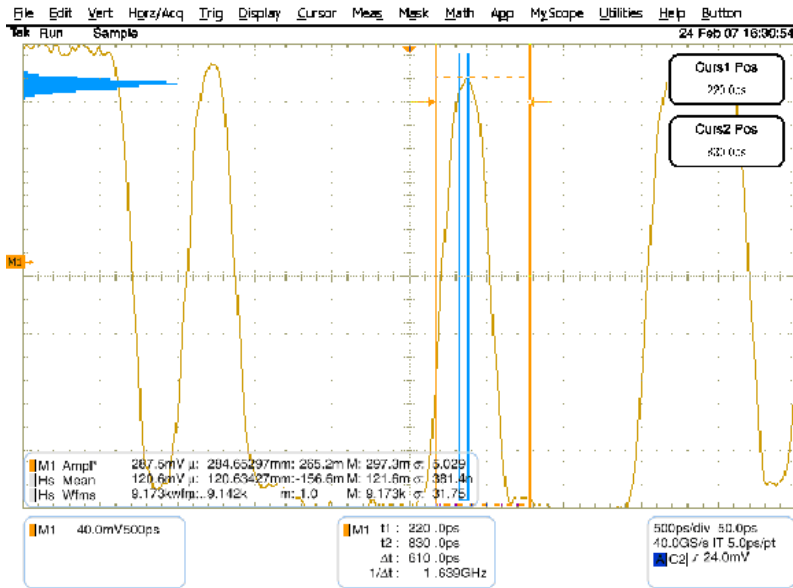

Transition Time Validation

Make sure the Rise and Fall time is in the nominal range of < 100 ps. This can be verified using the JIT3 application with same setup files used for Jitter calibration/validation. Rise and Fall time measurements allow you to validate that the transition rate does not exceed 100 ps 20/80.

Measurement	Sources	Population	Mean	StdDev
Data TIE1	M1	1012474	-127.88fs	29.984ps
Data PLL TIE1	M1	1012474	-129.51fs	30.393ps
Rise Time1	M1	507839	108.31ps	5.8361ps
Fall Time1	M1	507838	106.33ps	5.5801ps

After the completion of calibration process, Calibrated Voltage swing required in the jittered waveform, Calibrated Random Jitter, Optimal value for Amplitude of jittered frequency are available and can be used for generating waveforms for RSG and RMT tests.

Setting User Option for SATA DUT Power Cycle Method

TekExpress SATA offers three methods that you can choose from for power cycle operation of SATA DUTs during the test sequence. You also have an option to fully customize the DUT power cycle operation automation sequence. Following are the options for defining the SATA DUT power cycle method:

- Manual Power Cycle
- Power Cycle using AWG DC output to control AT/ATX power supply (default setting)
- User specified TestStand sequence

For more details on how to use and configure these options, refer to the [DUT-PowerCycle.txt](#) file located under ICP folder of TekExpress installed folder location.

```

# =====
# Note: Read and use this file very carefully.
# Lines with # prefix are considered comments.
# This file defines the way SATA DUT Power Cycle operation is performed during test automation.
# The first line in this TXT file that does not have # character defines the SATA DUT Power Cycle
operation.
# This line should contain one of following keywords (without quotes).
# "Manual", "AWG", "User Defined GPIB", "User Defined TestStand Steps".
# If anything other than above valid keyword is found then Manual method overrides.
# "Manual" : This assumes manual operation of power cycle.
# "AWG" : This assumes AT/ATX power supply is controlled through DC output of AWG.
# Connect Channel-1 of DC output to pin #14 (and pin #15 to GND) in case of 20 pin Molex
connector of AT/ATX power supply.
# Connect Channel-1 of DC output to pin #16 (and pin #17 to GND) in case of 24 pin Molex
connector of AT/ATX power supply.
# "User Defined GPIB" : This assumes a user defined sets of GPIB commands are defined.
# in lines following the valid keyword "User Defined GPIB". (This feature is not active).
# "User Defined TestStand Steps" : This assumes the power cycle steps are defined in
"UserDefinedTurnOFF" & "UserDefinedTurnON" sequence of "ICP_DUT-PowerSupply.seq" file.
# =====
AWG
Delete this line and start GPIB commands from here onwards, each line assumed to be one command,
you need to take care of complete sequencing from VI_open till VI_close.

```

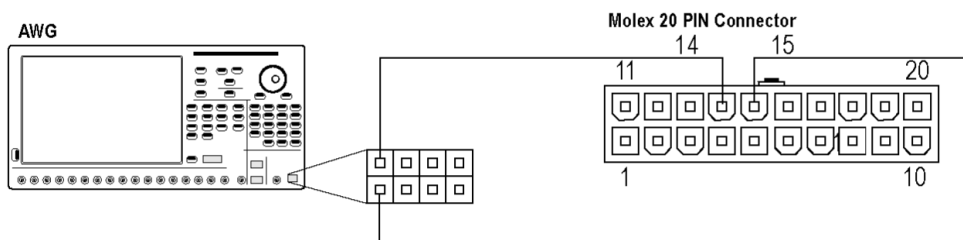

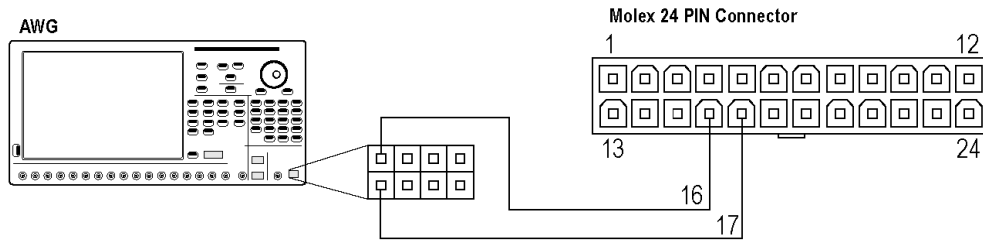

About JTF Calibration and Verification

In an effort to get better correlation between different jitter measurement systems, the SATA PHY group has defined a standard jitter transfer function requirement which all jitter measurement systems must meet. This is detailed in ECN-008. The following procedure describes the process for performing the Jitter Transfer Function calibration. This calibration must be done once prior to making TSG-09 through TSG-12.

The response to jitter of the Jitter Measurement Device (JMD)(the reference clock is part of the JMD) is measured with three different jitter modulation frequencies corresponding to the following three cases:

- SSC (full tracking)
- Jitter (no tracking)
- The boundary between SSC and jitter

The jitter source is independently verified by separate means. This ensures that the jitter response of the JMD is reproducible across different test setups.

The three test signals are:

- A 750 MHz $\pm 0.035\%$ sine or square wave with a sinusoidal phase modulation of 20.8 ns $\pm 10\%$ peak to peak at 30 kHz $\pm 1\%$.
- A 750 MHz sine or square wave with a sinusoidal phase modulation of 100 ps $\pm 10\%$ peak to peak at 50 MHz $\pm 1\%$.
- A 750 MHz sine or square wave with a sinusoidal phase modulation of 100 ps $\pm 10\%$ peak to peak at 50 MHz $\pm 1\%$.

The independent separate means of verification of the test signals is a time interval error plot on a real time oscilloscope.

The test procedure checks two conditions: the JTF attenuation and the JTF bandwidth. Care is taken to minimize the number of absolute measurements taken, making most relative; this reduces the dependencies and improves accuracy.

Click the following links to view the basic and detailed procedures:

[Basic Procedure](#)

[Procedure in detail](#)

Basic Procedure

Related Topics

[About JTF Calibration and Verification](#)

[Detailed Procedure](#)

The basic procedure to perform Jitter transfer function calibration is as follows:

1. Adjust the pattern generator for a D24.3 pattern (00110011) (Gen2 is a 750 MHz sine wave) and modulation to produce a 30 KHz $\pm 1\%$, 20.8 ns p-p $\pm 10\%$ sinusoidal phase modulation.
2. Verify the level of modulation meets the requirements and record the p-p level (DJ t). This is done with a Time Interval Error (TIE) type measurement or equivalent.
3. Apply test signal to the JMD. Turn on the sinusoidal phase modulation. Record the reported DJ.
4. Turn off the sinusoidal phase modulation. Record the reported residual DJ.
5. Calculate and record the level of applied DJ by subtracting the DJ with modulation off from DJ with modulation on.
6. Calculate the jitter attenuation by $20 \times \log(\text{DJm}/\text{DJt})$. This value must fall within the range of $-72 \text{ dB} \pm 3 \text{ dB}$. Adjust the JMD settings to match this requirement.
7. Adjust the pattern generator for a D24.3 pattern (00110011) (Gen2 is a 750 MHz sine wave) and modulation to produce a 50 MHz $\pm 1\%$, 0.3 UI p-p $\pm 10\%$ (100 ps) sinusoidal phase modulation.
8. Verify the level of modulation meets the requirements and record the p-p level (DJ t). This is done with a Time Interval Error (TIE) type measurement or equivalent.
9. Apply the test signal to the JMD. Record the level as the reference DJ value (DJ 0dB).
10. Calculate the -3 dB value: $\text{DJ-3 dB} = \text{DJ0 dB} \times 10^{(-3/20)}$
11. Adjust the frequency of the DJ source to 2.1 MHz. Shift the frequency of the PJ source until the reported DJ difference between PJ on versus PJ off is equal to (DJ -3 dB). The PJ frequency is the -3 dB BW of the JTF.
12. Adjust the JMD settings to bring the PJ -3 dB frequency to $2.1 \text{ MHz} \pm 1 \text{ MHz}$. Repeat step 4 through step 12 until both the jitter attenuation and 3 dB frequency are in the acceptable ranges.
13. Check the peaking of the JTF. Adjust the pattern generator for a D24.3 pattern and modulation to produce sinusoidal phase modulation at the -3 dB frequency and 0.3 UI p-p $\pm 10\%$ (100 ps). Increase the frequency of the modulation to find a maximum jitter; it is not necessary to increase beyond 20 MHz. Record the maximum jitter value and frequency.
14. Calculate the JTF Peaking value: $20 \times \log(\text{DJpkng}/\text{DJ0dB})$. Record this value.

Detailed Procedure

Related Topics

[About JTF Calibration and Verification](#)

[Basic Procedure](#)

Required Equipment

- AWG7102 with Opt 6
- JTF Waveform Library for AWG7102
- Test cables
- DSA72004 Digital Phosphor Oscilloscope 20 GHz, 50 G/s, or desired BW
- JIT3 software and associated JTF setup files

Follow these steps to do the Jitter transfer function calibration:

- Step 1

Adjust the pattern generator for a D24.3 pattern (00110011)(MFTP) (Gen2 is a 750 MHz sine wave) and modulation to produce a 30 KHz $\pm 1\%$, 20.8 ns p-p $\pm 10\%$ sinusoidal phase modulation. To do this on the AWG7102, open the waveform file “SATA Gen2 30k 62_5Sj.awg”. This will set all the parameters of the AWG.

- a. Connect the AWG to the oscilloscope, using the same matched cable set that will be connected to the oscilloscope during normal jitter measurements. Verify that the cables are connected to the AWG Interleaved outputs.
- b. Select the “Gen2 30kHz 62_5sj” waveform from the Waveform List on the left side of the display. Drag this to the Waveform display window, and drop in the CH1 area. When the pop-up appears, choose “Set Waveform”.
- c. Set the AWG output to “On”. This will apply the MFTP pattern containing a 30 kHz modulation with 20.8 ns of jitter to the oscilloscope.

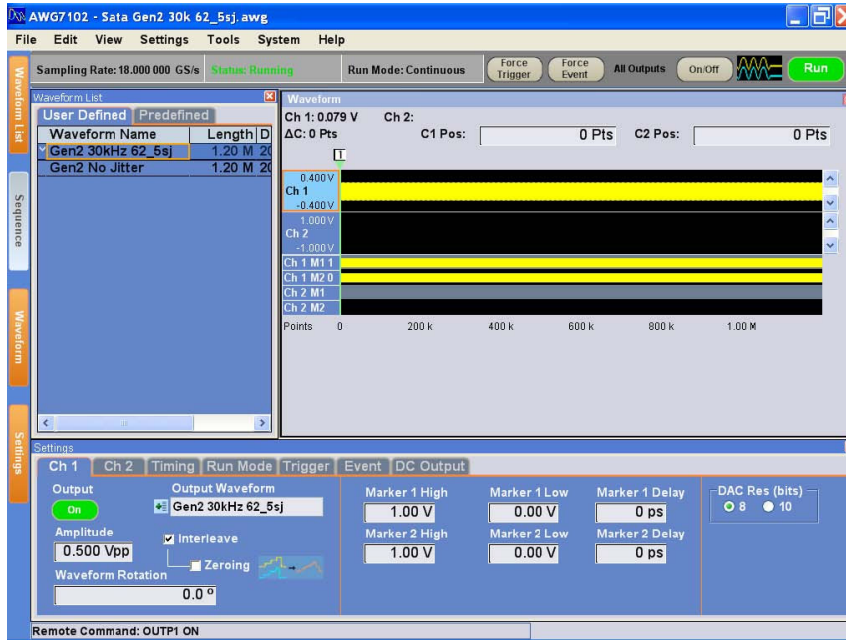

■ Step 2

Verify that the level of modulation meets the requirements and record the p-p level (DJ t). This is done with a Time Interval Error (TIE) type measurement or equivalent.

- a. Launch the Jitter Analysis (TDSJIT3) application under the Analyze menu on the oscilloscope.
- b. Recall the JIT3 settings file “JTF JIT3 Gen2 setup.ini”. This will set up the oscilloscope channels as well as the JIT3 settings. It will set up all needed measurements within JIT3. Reference levels will be set automatically when the measurement is run. Click the “TIE RjDj-BER” tab, and then click “Data TIE 1”. Click “Single” to run the measurement.



JIT3 produces a measurement for Dj in the statistics table, however this value cannot be used directly.

The setup file has automatically created several plots. Click the “Select View” button on the right side of the screen, and select the Data TIE1 Trend Plot. The resulting plot of a sine wave pattern may have a long slope which is due to offset values (initial conditions) which are integrated. The peak to peak value of the sinusoidal wave is of importance as this is the level of phase modulation. The long slope needs to be removed from the plot to find the accurate peak to peak phase modulation. To do this, use the cursors to take the average of two peaks vs one valley, thus eliminating the long slope.

Choose two adjacent peaks and the valley between to make the measurement. Place horizontal cursors on the trend plot, and position the cursors to the top of the first peak and the valley. Record the measured delta.

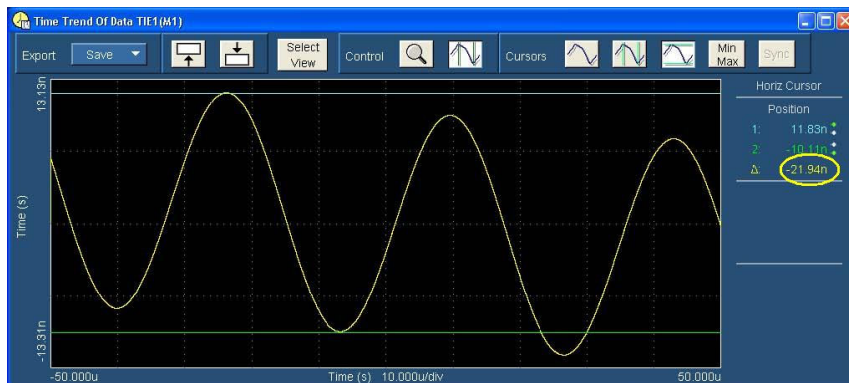

Next, move the top cursor to the second peak, and again record the measured delta.

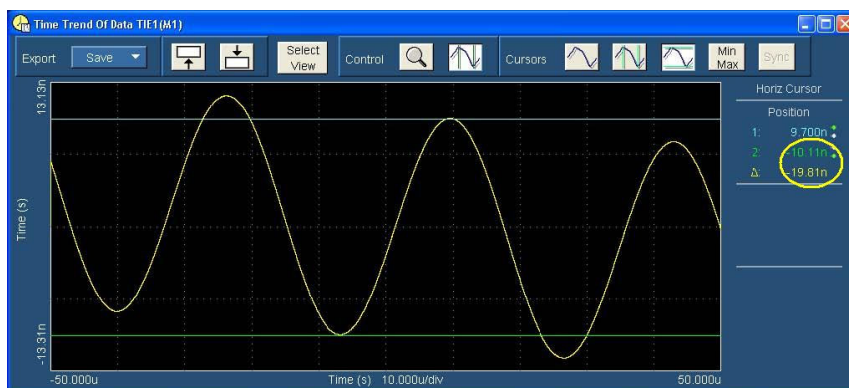

In this example, peak 1 is 21.94 ns, and peak 2 is 19.81 ns. The valley is the reference value.

Determine the slope corrected Dj value: $(21.94+19.81)/2 = 20.88$ ns. This verifies the level of phase modulation required. This measured value from the TIE agrees with the level set in the source. Record this value in the B7 cell of the JTF Calibration spreadsheet.

■ Step 3

Apply test signal to the JMD.

To make the JMD measurement on the 30 kHz modulated signal, simply click the Data PLL TIE 1 measurement in the JIT3 measurement list. It is not necessary to click the “Single” button to acquire another waveform, as the measurement was made on the last waveform acquired.

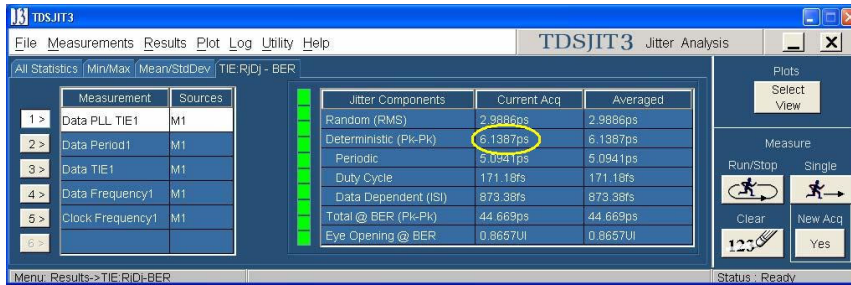

Record this measured value in the B8 cell of the JTF Calibration spreadsheet.

■ Step 4

Measure the residual jitter by turning off the 30 kHz modulation, and making another jitter measurement. On the AWG, drag the “Gen2 No Jitter” waveform from the waveform list to the waveform display area, and drop in CH1. When the pop-up window appears, select “Set Waveform”. Turn the AWG Ch1 output on.

On the oscilloscope, click the “Single” button to make another acquisition.

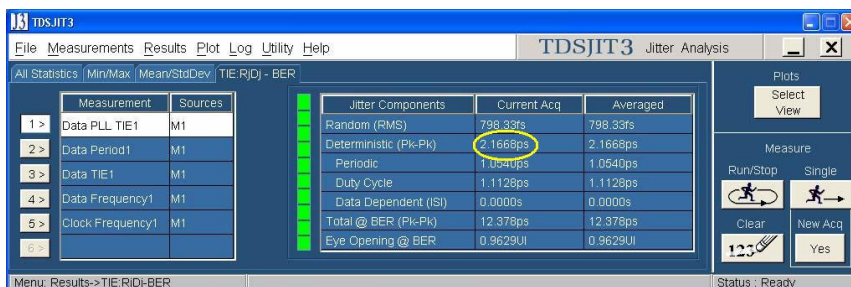

Record this measurement in the B9 cell of JTF Calibration spreadsheet.

The spreadsheet now has enough data to calculate the attenuation level of the JMD.

■ Step 5

The spreadsheet calculates the level of applied DJ by subtracting the DJ with modulation off from DJ with modulation on.

(For example, 6.1387 ps - 2.1668 ps = 3.9719 ps)

■ Step 6

Calculate the jitter attenuation by $20 \times \log(DJ_m/DJ_t)$. This value must fall within the range of $-72 \text{ dB} \pm 3 \text{ dB}$. Adjust the JMD loop bandwidth setting under the Clock Recovery setup to meet this requirement. (For example, $20 \times \log(3.9719 \text{ ps}/20.83 \text{ ns}) = 74.41 \text{ dB}$)

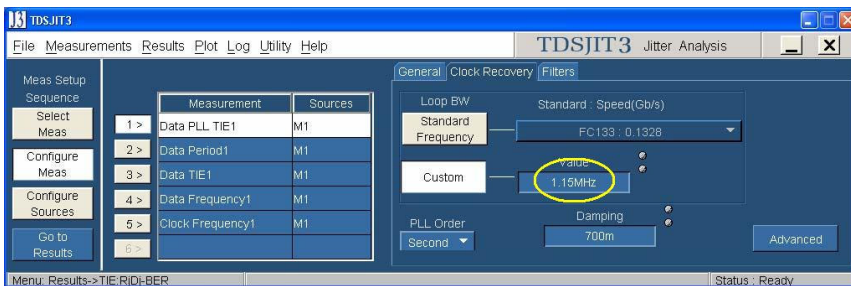

If the calculated attenuation is below -72 dB, decrease the loop bandwidth setting, and repeat the process from step 1 to 6 until the required attenuation is attained. Once the proper loop bandwidth has been determined, leave this value set for all subsequent measurements.

■ Step 7

Adjust the pattern generator for a D24.3 pattern (00110011) (Gen2 is a 750 MHz sine wave) and modulation to produce a 50 MHz ±1%, 0.3 UI p-p ± 10% (100 ps for Gen2) sinusoidal phase modulation. To do this on the AWG7102, open the waveform file “SATA Gen2 JTF 3db set.awg”. This will set all parameters of the AWG. This setup file includes a collection of waveforms that can be used to verify the -3 dB point on the jitter transfer curve.



■ Step 8

Select the SATA 50 M SJ waveform from the waveform list. On the oscilloscope, click “Single” to run the acquisition and measurement on JIT3. Click the DATA TIE 1 measurement, and record the measured Dj. Verify the level of modulation meets the requirements and record the p-p level (DJ t) in the B10 cell of the JTF Calibration spreadsheet.

The screenshot shows the TDSJIT3 Jitter Analysis interface. The 'Measurement' list on the left includes 'Data PLL TIE 1' (M1). The 'Jitter Components' table is as follows:

Jitter Components	Current Acq	Averaged
Random (RMS)	861.67fs	861.67fs
Deterministic (Pk-Pk)	102.06ps	102.06ps
Periodic	101.94ps	101.94ps
Duty Cycle	121.83fs	121.83fs
Data Dependent (ISI)	0.0000s	0.0000s
Total @ BER (Pk-Pk)	112.35ps	112.35ps
Eye Opening @ BER	0.6629UI	0.6629UI

Next, click the “Data PLL TIE 1” in the measurement list, and record the measured Dj in the B11 cell of the JTF Calibration spreadsheet.

The screenshot shows the TDSJIT3 Jitter Analysis interface. The 'Measurement' list on the left includes 'Data PLL TIE 1' (M1). The 'Jitter Components' table is as follows:

Jitter Components	Current Acq	Averaged
Random (RMS)	846.82fs	846.82fs
Deterministic (Pk-Pk)	112.59ps	112.59ps
Periodic	101.11ps	101.11ps
Duty Cycle	120.46fs	120.46fs
Data Dependent (ISI)	11.364ps	11.364ps
Total @ BER (Pk-Pk)	121.26ps	121.26ps
Eye Opening @ BER	0.6362UI	0.6362UI

■ Step 9

On the AWG, select the waveform “Gen2 No Jitter”. This is used to verify the residual jitter at this setting. Again measure and record the Data PLL TIE 1 Dj using JIT3 in the B12 cell of JTF Calibration spreadsheet. This establishes the reference DJ value of excitation that is applied to the JMD. Record the measured jitter level as the reference DJ value (DJ 0dB).

■ Step 10

The JTF Calibration spreadsheet then calculates the -3 dB value: $DJ-3\text{ dB} = DJ\ 0\text{ dB} \times 0.708$.

■ Step 11

Determine the specific frequency that matches the -3 dB level found in step 10. This is done by sequentially setting the AWG Dj frequency in a range from 1.1 MHz to 3 MHz. At each setting, the measurement is made on the oscilloscope using the Data PLL TIE 1 measurement. Assume the residual DJ is zero for the search (this speeds up the search).

Once the -3 dB frequency is determined, record the measured Dj at that frequency into cell B13 of the JTF Calibration spreadsheet. Turn off the jitter modulation on the AWG by again selecting the Gen2 No Jitter waveform. Retake the measurement to get the residual, and enter this into the spreadsheet at cell B14. Enter the -3 dB frequency in spreadsheet cell B15.

■ Step 12

Verify the DJ -3 dB frequency is $2.1\text{ MHz} \pm 1\text{ MHz}$. The typical -3 dB frequency is approximately 1.55 MHz. Repeat step 4 through step 12 until both the jitter attenuation and 3 dB frequency meet the requirements of the specifications contained in ECN-008.

■ Step 13

Check the peaking of the JTF. Adjust the pattern generator for a D24.3 pattern and modulation to produce sinusoidal phase modulation at the -3 dB frequency and 0.3 UI p-p ± 10% (200 ps for Gen1, 100 ps for Gen2). This is done on the AWG by opening the file “Sata JTF peak set.awg”. This provides waveforms containing the prescribed amount of jitter at frequencies ranging from 3 MHz to 20 MHz.

To find the peaking of the JTF requires multiple jitter measurements which may be time consuming. The JTF peaking is flat over a portion of the range. Start at the 3 dB frequency setting, and increment by 1 MHz until reaching 20 MHz or the readings start to decrease. Record the maximum jitter value and frequency. Once the peaking frequency is determined, enter the Dj value measured at that frequency into the spreadsheet at cell B16. Again determine the residual level by turning off the jitter on the AWG, and enter that measured residual jitter into the spreadsheet at cell B17. Enter the peaking frequency at cell B18 of the spreadsheet.

■ Step 14

The spreadsheet provides a calculation of the peaking level using the formula: $20 \times \log[(DJ\text{-peaking})/(DJ\text{-}0\text{dB})]$

Typical peaking for the Tek system is 3 MHz. The following is a completed example.

Cal performed on 11/06/07 using Dj (pp)									
	Recorded Values	Calculated Values	Calculated Values	Hi Lim	Lo Lim	Result	Notes		
Data Frequency	7.5000E+08			7.5026E+08	7.4974E+08	PASS			
SSC Frequency	3.0010E+04			3.0300E+04	29700	PASS			
Tj	20.837e-9	Rj	2.0625e-12						
DJSSC, applied PM at 30kHz	2.1518E-08			2.288E-08	1.872E-08	PASS	Measured using DATA TIE with no PLL or filtering applied		
DJSSCON, measured jitter at 30kHz	6.43E-12						Loop bandwidth set to 1.12MHz		
DJSSCOFF, measured residual jitter at 30kHz	1.94E-12	DJMSSC	4.494E-12	Attenuation	-73.602604	-69	-75	PASS	If this number does not come out very close to -72, adjust the loop bandwidth, and test again
DJM, applied jitter at 50MHz	1.0205E-10				1.100000E-10	9.000000E-11	PASS	50M jittered signal	Measured using DATA TIE with no PLL or filtering applied
DJMON, measured jitter at 50MHz	1.1266E-10								50M jittered signal measured using DATA PLL TIC
DJMOFF, measured residual jitter at 50MHz	1.7457E-12	DJMM	1.109E-10	DJ3DB	7.8416E-11				Measure the residual again by setting source to no jitter 3dB down Level in cell F12
DJON, measured jitter at 3dB point	8.1445E-11								
DJOFF, measured residual jitter at 3dB point	1.7787E-12	DJ	7.967E-11						Adjust the input Sj frequency until this number matches the value shown in cell F12
F3DB, 3dB frequency	1.55E+06				3.10E+06	1.10E+06	PASS	Note: -3db actually likely to be 1.525 or 1.53MHz	
DJPKON, measured jitter at peaking frequency	1.34E-10								Now sweep the Sj freq from 1MHz to 20MHz, and find the highest PLL TIE jitter value. Record here.
DJPKOFF, measured residual jitter at peaking frequency	1.9494E-12	DJPK	1.323E-10	Peaking:	1.53	dB Peaking			
FPK, peaking frequency	3.00E+06								

■ Step 15

Update the JIT3 setup files that TekExpress will be using with above calculated values. Update the following JIT3 setup files.

Test name	UTD 1.2	UTD 1.3
TSG -07 - Tj at Connector, Clock to Data, Fbaud/10	UTD 1.2_TSG07_08Ref_HFTP-Gen 1.ini	UTD 1.3_TSG07_08Ref_HFTP-Gen 1.ini
TSG -08 - Dj at Connector, Clock to Data, Fbaud/10	UTD 1.2_TSG07_08Ref_LBP-Gen 1.ini	UTD 1.3_TSG07_08Ref_LBP-Gen 1.ini
TSG -09 - Tj at Connector, Clock to Data, Fbaud/500	UTD 1.2_TSG09_10Ref_HFTP-Gen 1.ini	UTD 1.3_TSG09_10Ref_HFTP-Gen 1.ini
TSG -10 - Dj at Connector, Clock to Data, Fbaud/500	UTD 1.2_TSG09_10Ref_LBP-Gen 1.ini	UTD 1.3_TSG09_10Ref_HFTP-Gen 1.ini
TSG -11 - Tj at Connector, Clock to Data, Fbaud/500	UTD 1.2_TSG11_12Ref_HFTP-Gen 1.ini	UTD 1.3_TSG11_12Ref_HFTP-Gen 1.ini UTD 1.3_TSG11_12Ref_LBP-Gen 1.ini
TSG -12 - Dj at Connector, Clock to Data, Fbaud/500	UTD 1.2_TSG11_12Ref_LBP-Gen 1.ini	UTD 1.3_TSG11_12Ref_LBP-Gen 1.ini

OOB-01 Level Calibration Procedure using DPOJET Application

Follow these steps to calibrate AWG7102 using the DPOJET application:

■ Step 1

This procedure requires that the oscilloscope has been properly set up prior to making any measurement. This includes a 20 minute warm-up, running SPC, applying any required external attenuation, entering the attenuator values into the oscilloscope's vertical setup, and performing channel deskew. Once this is done, the oscilloscope can be connected to the SATA test fixture.

■ Step 2

In addition, this procedure requires that the AWG has been properly set up prior to making any measurements. This includes a 20 minute warm-up, and running the system calibration. Once this is complete, the AWG can be connected to the SATA test fixture.

■ Step 3

After the equipment has been properly set up, connect a loop-back to the SATA Near End fixture. This loop-back consists of a SATA Far End fixture, and short SMA cables which connect the Transmitter D+ to the Receiver D+, and the Transmitter D- to the Receiver D-. If a loop-back is not available, it is acceptable to disconnect the SATA test fixture, and connect the Tx and Rx cables together using SMA barrel connectors.

■ Step 4

On the AWG, open the "CRST02-3G210-6x.awg" file. This produces an OOB COMINIT/COMRESET burst set that is approximately 210 mV in amplitude.

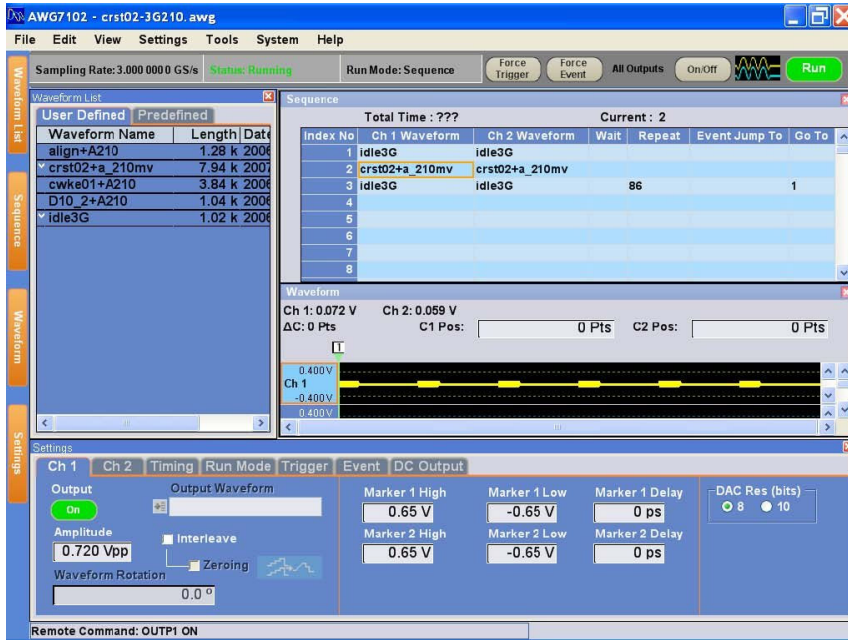

■ Step 5

On the oscilloscope, launch the Jitter and Eye Analysis package (DPOJET).

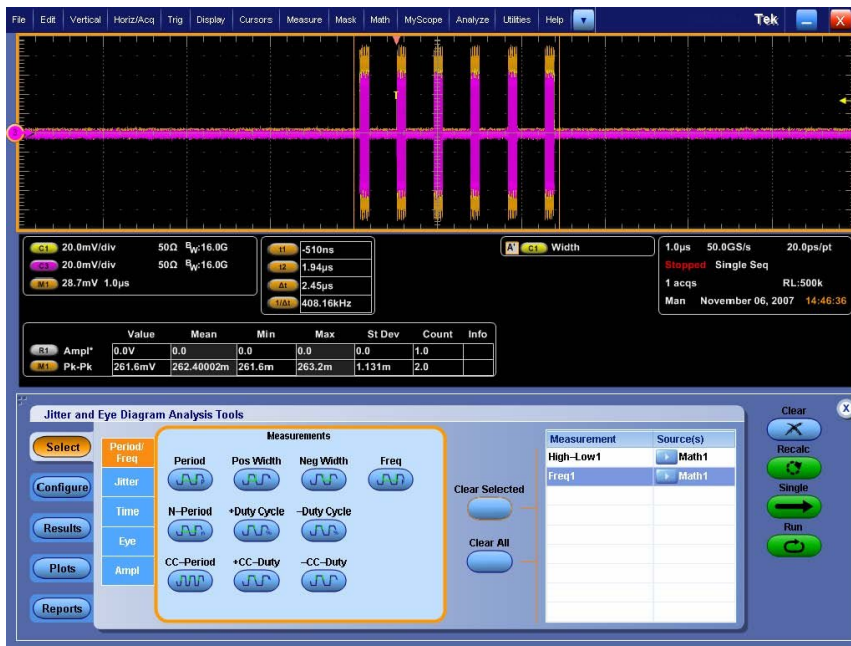

■ Step 6

Recall the settings file “SATA OOB 210mv cal”. This will configure the oscilloscope as well as the DPOJET settings.

Note that the SATA Logo group has defined this measurement to be made using a MODE measurement on the .45 to .55 (center 10%) portion of the UI, and to average the MODE measurements of all of the UI contained in all of the COMINIT bursts. It is not necessary to manually set the DPOJET settings after loading the settings file, but the following screen shows the settings that are created by the “SATA OOB 210mv cal” setup file:



■ Step 7

Click the “Run” button, and while the measurement is running, adjust the AWG output amplitude as close as possible to 210 mV. It might be convenient to stop the measurement, clear the previous data, and restart the data to get a more accurate reading. If everything is configured properly, it will be easy to get better than 1% error (± 2 mV) on this adjustment. The following screen shows the adjustment window:



■ Step 8

The results will be displayed in the following location:

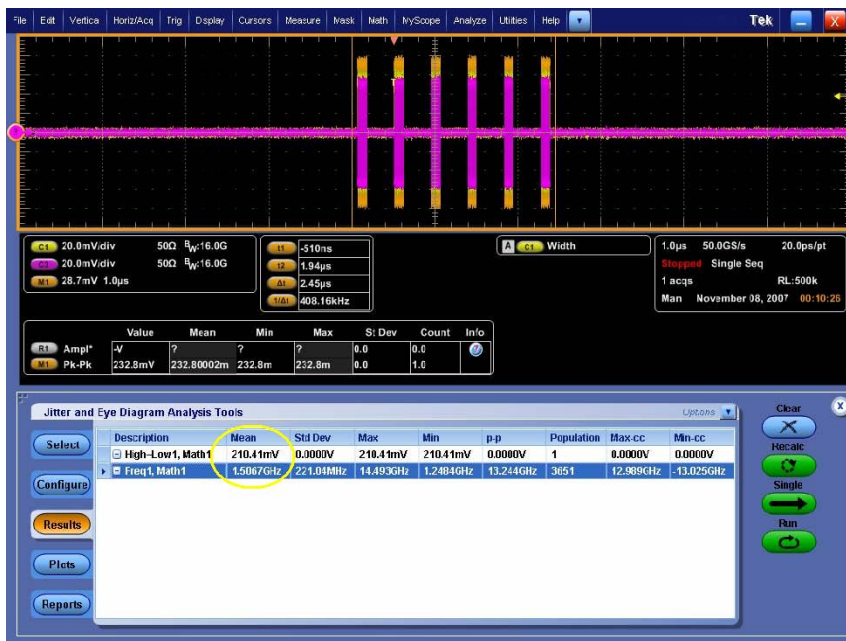

- Step 9

Repeat the procedure for the 40 mV and 60 mV settings. The AWG files used to generate the signals are “CRST02-3G040-6x.awg” and “CRST02-3G060-6x.awg”. The setup files for the oscilloscope to make these measurements are “SATA OOB 40mv cal.set” and “SATA OOB 60mv cal.set”.

OOB-01 Calibration Procedure without using the DPOJET Application

The objective of the procedure is to add or subtract a residue voltage level from the AWG to exactly see 210 mV, 60 mV or 40 mV levels on the OOB1 stimulus captured on oscilloscope. On the AWG, open the “CRST02-3G210-6x.awg” file. This produces an OOB COMINIT/COMRESET burst set that is approximately 210 mV in amplitude.

NOTE. *The calibration procedure without using the DPOJET application is applicable only to TDS Oscilloscopes.*

This procedure requires that the oscilloscope has been properly set up prior to making any measurements. This includes a 20 minute warm-up, running SPC, applying any required external attenuation, entering the attenuator values into the oscilloscope’s vertical setup, and performing channel deskew. Once this is done, the oscilloscope can be connected to the SATA test fixture.

In addition, this procedure requires that the AWG has been properly set up prior to making any measurements. This includes a 20 minute warm-up, and running the system calibration. Once this is complete, the AWG can be connected to the SATA test fixture.

After the equipment has been properly set up, connect a loop-back to the SATA Near End fixture. This loop-back consists of a SATA Far End fixture, and short SMA cables which connect the Transmitter D+ to the Receiver D+, and the Transmitter D- to the Receiver D-. If a loop-back is not available, it is acceptable to disconnect the SATA test fixture, and connect the Tx and Rx cables together using SMA barrel connectors.

On the AWG, open the “CRST02-3G210-6x.awg” file. This produces an OOB COMINIT/COMRESET burst set that is approximately 210 mV in amplitude.

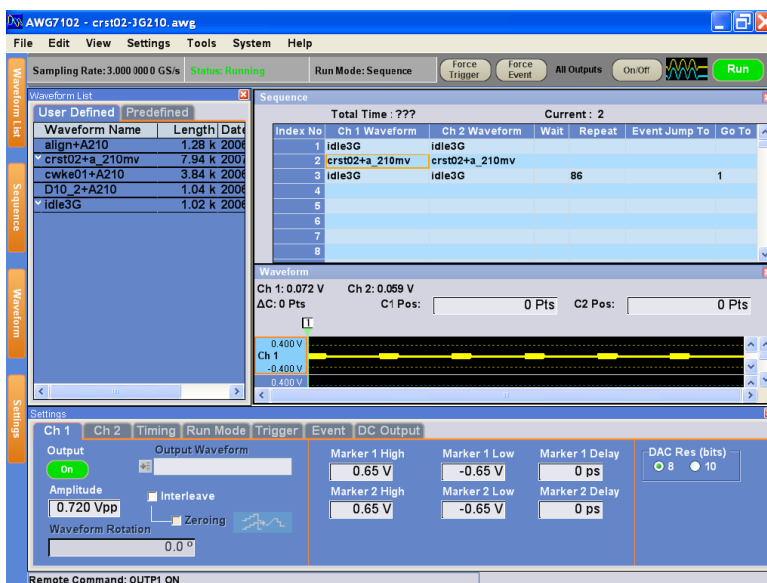

Capture the differential waveform on a TDS oscilloscope. Create a math channel from the differential inputs and enable display of it.

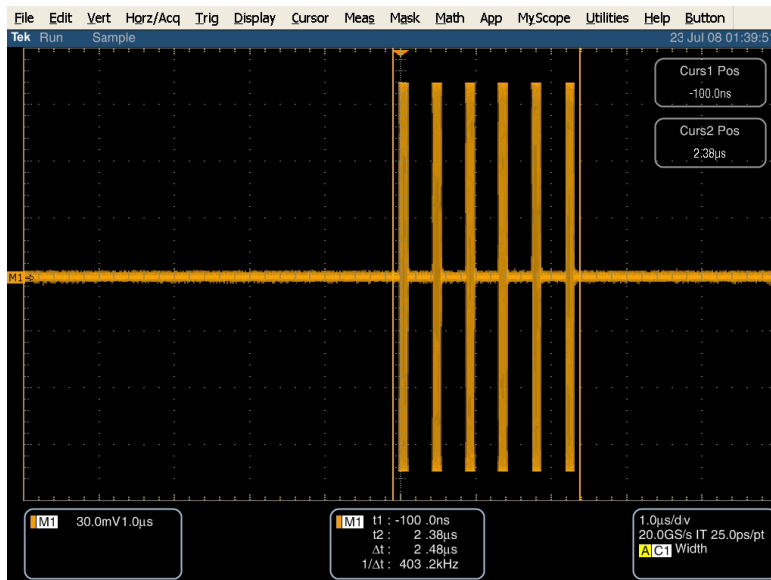

To perform the calibration we need to find the amplitude of the waveform. But it is not a peak- to- peak measurement available in measurements feature of TDS oscilloscope.

Note that the SATA Logo group has defined this measurement to be made using a MODE measurement on the .45 to .55 (center 10%) portion of the UI, and to average the MODE measurements of all of the UI contained in all of the COMINIT bursts.

Save the math waveform with a name such as COMRESET_Diff.wfm

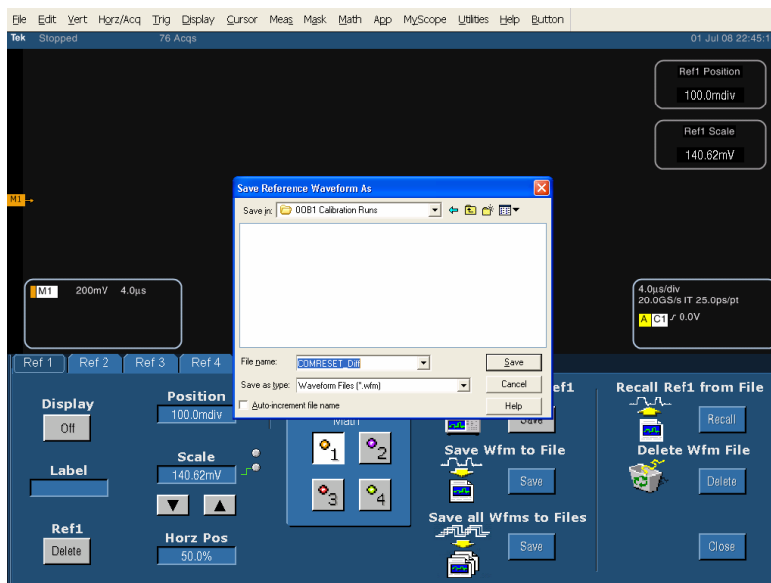

To measure MODE on these epochs, run SATAOOB . EXE utility with the saved waveform as the argument.

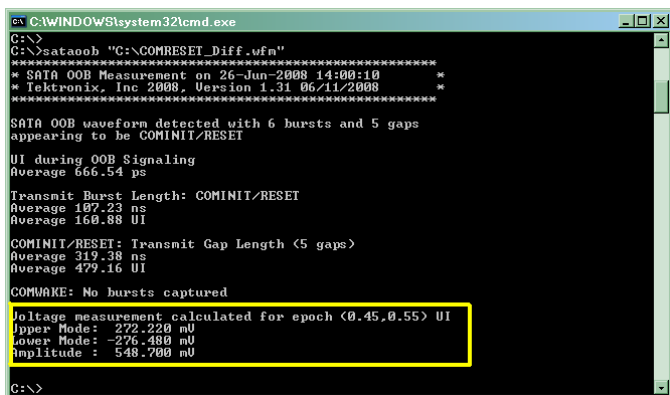

The Amplitude value here is $548.7/2 = 274.35$ mV. The amount of AWG output level to be reduced is $274.35 - 210 = 64.35$ mV.

Take another capture from the TDS and run the SATAOOB utility on the saved waveform file. Another delta value can be computed. Keep adding or subtracting this value on the AWG output till the measured value on the oscilloscope with this utility comes close to 210 mV. An allowable limit is $\pm 1\%$. In the case of 210 mV waveform it is ± 2 mV. And in the case of 40 mV waveform it is ± 0.04 mV. The following screen shows the window for adjusting the amplitude.



The results will be displayed on the oscilloscope in the following location:

Repeat the procedure for the 40 mV and 60 mV settings. The AWG files used to generate the signals are “CRST02-3G040-6x.awg” and “CRST02-3G060-6x.awg”. The setup files for the oscilloscope to make these measurements are “SATAOOB 40mv cal.set” and “SATA OOB 60mv cal.set”.

About the Programmatic Interface

Related Topics
[Server and Client Proxy Objects](#)

The Programmatic interface allows you to seamlessly integrate the TekExpress test automation application with the high-level automation layer. This also allows you to control the state of TekExpress application running on a local or a remote PC. Following operations can be performed using the programmatic interface exposed by TekExpress:

- Query DUT ID
- Set DUT ID
- SaveSession
- RecallSession
- Run the TekExpress execution
- Stop the TekExpress execution
- Query execution status
- Transfer result files
- Check the application status

For simplifying the descriptions, the following terminologies are used in this section:

- **TekExpress Client:** A High level automation application that communicates with TekExpress using TekExpress Programmatic Interface.
- **TekExpress Server:** The TekExpress application when being controlled by TekExpress Client.

TekExpress leverages .Net Marshalling to enable the Programmatic Interface for TekExpress Client. TekExpress provides a client library for TekExpress clients to use the programmatic interface. The TekExpress client library is inherited from .Net MarshalByRef class to provide the proxy object for the clients. The TekExpress client library maintains a reference to the TekExpress Server and this reference allows the client to control the server state.

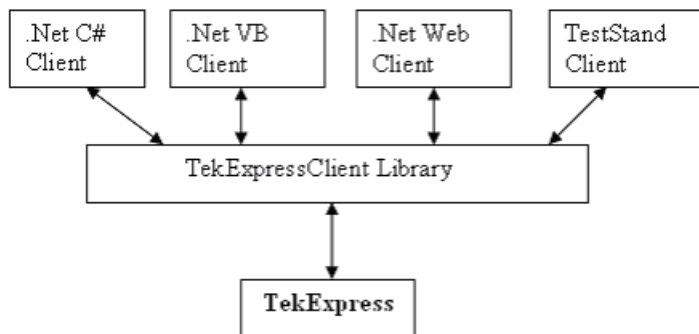

Click the following links to get details on them:

What does one need to have to develop TekExpress Client ?

While developing TekExpress Client one needs to use the TekExpressClient.dll. The client can be a VB .Net, C# .Net, TestStand or web application. The examples for interfaces in each of these applications are in Samples folder.

References required

TekExpressClient.dll has internal reference to *IIdlglib.dll* and *IRemoteInterface.dll*. *IIdlglib.dll* has a reference to *TekDotNetLib.dll*. *IRemoteInterface.dll* provides the interfaces required to perform the remote automations. It is an interface that forms the communication line between the server and the client. *IIdlglib.dll* provides the methods to generate and direct the secondary dialog messages at the client-end.

NOTE. *The end-user client application does not need any reference to above mentioned DLL files. It is essential to have these DLLs (IRemoteInterface.dll, IIdlglib.dll and TekDotNetLib.dll) in same folder location as that of TekExpressClient.dll.*

What steps does a client need to follow ?

The following are the steps that a client needs to follow to use the TekExpressClient.dll to programmatically control the server:

A client UI has to be developed to access the interfaces exposed through the server. This client needs to load `TekExpressClient.dll` to access the interfaces. Once the TekExpressClient.dll is loaded, the client UI can call the specific functions to run the operations requested by the client. Once the client is up and running, it has to do the following to run a remote operation:

1. The client needs to provide the IP address of the PC at which the server is running in order to connect to the server.
2. The client needs to lock the server application to avoid conflict with any other Client that may try to control the server simultaneously. “Lock” would also disable all user controls on server so that server state cannot be changed by manual operation.
3. If any other client tries to access a server which is locked, it will get a notification that the server is locked by another client.
4. When the client has connected to and locked the server, the client can access any of the programmatic controls to run the remote automations.
5. Once the client operations are completed, the server needs to be “unlocked” by the client.

Server and Client Proxy Objects

Remote Proxy Object

The server exposes a remote object to let the remote client access and perform the server side operations remotely. The proxy object is instantiated and exposed at the server-end through marshalling.

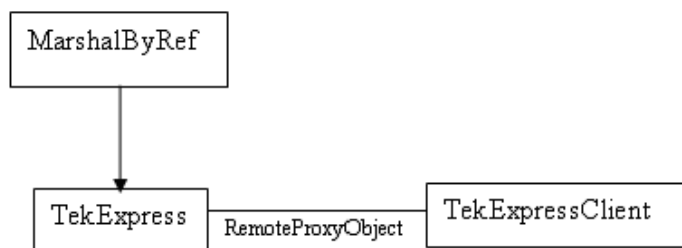

The following is an example:

```
RemotingConfiguration.RegisterWellKnownServiceType (typeof (TekExpressRemoteInterface), "TekExpress Remote interface", wellKnownObjectMode.Singleton);
```

This object lets the remote client access the interfaces exposed at the server side. The client gets the reference to this object when the client gets connected to the server.

For example,

```
//Get a reference to the remote object
```

```
remoteObject = (IRemoteInterface)Activator.GetObject(typeof(IRemoteInterface), URL.ToString());
```

Client Proxy Object

Client exposes a proxy object to receive certain information.

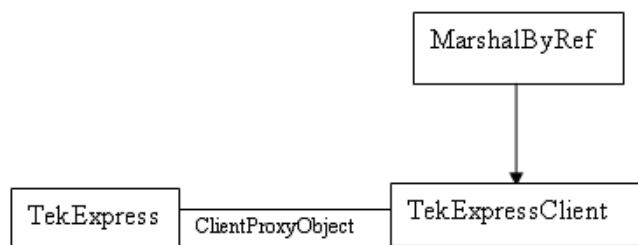

For example,

```
//Register the client proxy object
```

```
wellKnownServiceTypeEntry[] e = RemotingConfiguration.GetRegisteredWellKnownServiceTypes();
```

```
clientInterface = new ClientInterface();
```

```
RemotingConfiguration.RegisterWellKnownServiceType(typeof(ClientInterface),  
"Remote Client Interface", wellKnownObjectMode.Singleton);
```

```
//Expose the client proxy object through marshalling
```

```
RemotingServices.Marshal(clientInterface, "Remote Client Inteface");
```

The client proxy object is used for the following:

1. To get the secondary dialog messages from the server.
2. To get the file transfer commands from the server while transferring the report.

Click here to see examples.

```
clientObject.clientIntf.DisplayDialog(caption, msg, iconType, btnType);
```

```
clientObject.clientIntf.TransferBytes(buffer, read, fileLength);
```

To know more on the topics below, click the links.

Secondary Dialog Message Handling

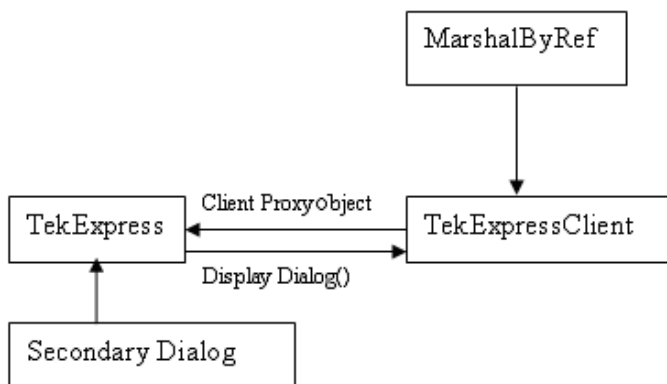

The secondary dialog messages from the Secondary Dialog library are redirected to the client-end when a client is performing the automations at the remote end.

In the secondary dialog library, the assembly that is calling for the dialog box to be displayed is checked and if a remote connection is detected, the messages are directed to the remote end.

File Transfer Events

When the client requests the transfer of the report, the server reads the report and transfers the file by calling the file transfer methods at the client-end.

Connect()

Connect(*string* ipAddress, *out string* clientID)

This method connects the client to the server. The client provides the ip address of the server to connect to the server. The server provides a unique clientID when the client is connected to it.

Parameters

Name	Type	Direction	Description
ipAddress	string	IN	The ip address of the server to which the client is trying to connect to. This is required to establish the connection between the server and the client.
clientid	String	OUT	Identifier of the client that is connected to the server. clientid = unique number + ipaddress of the client. For example, 1065-192.157.98.70

Return Value

Value that suggests the status if the connection was established or an error occurred. The return value is an object that can be a boolean value, returning true or a string, returning the error message.

Example

```
try {
    IPAddress[] hostIPAddr = Dns.GetHostAddresses(Dns.GetHostName());
    // Connect to the remoter Server
    remoteObject.Connect(hostIPAddress, clientInterface, out clientID);
    return true;
}
catch (Exception error)
{
    return error;
}
```

Comments

The server has to be active and running for the client to connect to the server. Any number of clients can be connected to the server at a time. Each client will get a unique id.

Disconnect()

Disconnect(*string* id)

This method disconnects the client from the server it is connected to.

Parameters

Name	Type	Direction	Description
id	String	IN	Identifier of the client that is performing the remote function.

Return Value

Integer value that suggests the status of the operation after it has been performed.

1 – Success

-1 – Failure

Example

```
try
{
    string returnUrl = UnlockServer (clientId);
    remoteObject.Disconnect (clientId);
    return 1;
}
```

Comments

When the client is disconnected, it is unlocked from the server and then disconnected. The id is reused.

LockSession()

LockSession(*string* id)

This method locks the server. The client has to call this method before running any of the remote automations. The server can be locked by only one client.

Parameters

Name	Type	Direction	Description
id	String	IN	Identifier of the client that is performing the remote function.

Return Value

String value that suggests the status of the operation after it has been performed.

Example

```
if (!locked)
    return "Session has already been locked!";
returnVal = remoteObject.LockSession(clientId);
if ((OP_STATUS)returnVal == OP_STATUS.SUCCESS)
{
    locked = true;
    return "Session Locked...";
}
```

Comments

When the client tries to lock a server that is locked by another client, the client gets a notification that the server is already locked and it has to wait until the server is unlocked.

If the client locks the server and is idle for a certain amount of time then the server is unlocked automatically from that client.

UnlockSession()

UnlockSession(*string* id)

This method unlocks the server from the client. The client id of the client to be unlocked has to be provided.

Parameters

Name	Type	Direction	Description
id	string	IN	Identifier of the client that is performing the remote function.

Return Value

String that suggests the status of the operation after it has been performed.

Example

```
returnVal = remoteObject.UnlockSession(clientId);  
if ((OP_STATUS)returnVal == OP_STATUS.SUCCESS)  
{  
    locked = false;  
    return "Session Un-Locked...";  
}
```

Comments

When the client is disconnected, it is automatically unlocked.

SetTimeout()

SetTimeout (*string* id, *string* time)

Parameters

Name	Type	Direction	Description
id	string	IN	Identifier of the client that is performing the remote function.

Name	Type	Direction	Description
time	string	IN	The time in seconds which refers to the timeout period.

Return Value

String that suggests the status of the operation after it has been performed.

Example

```
if (ClientId == ClientID)
{
    if (locked == true)
    {
        tempTime = Int32.Parse(time);
    }
    if (tempTime < 0)
        return "Enter a valid Timeout Period";
    else
    {
        timeout = tempTime;
        return "Timeout Period Changed";
    }
}
```

Comments

The time parameter gives the timeout period, that is the time the client is allowed to be locked and idle. After the timeout period if the client is still idle, it gets unlocked.

The time parameter should be a positive integer. Else, the client is prompted to provide a valid timeout period.

GetTimeOut()

GetTimeOut (*string* id)

Parameters

Name	Type	Direction	Description
id	string	IN	Identifier of the client that is performing the remote function.

Return Value

String that suggests the status of the operation after it has been performed.

Example

```
if (ClientId == ClientID)
{
    ResetTimer();
    return timeOut.ToString();
}
```

Comments

The timeout period is a positive integer.

GetDutId()

GetDutId(*string* id, *string* dutId)

This method gives the DUT id of the current set-up.

Parameters

Name	Type	Direction	Description
id	string	IN	Identifier of the client that is performing the remote function.
dutId	string	OUT	The DUT id of the set-up.

Return Value

String that gives the timeout period (in seconds) of the client.

Example

```
returnVal = remoteObject.GetDutId(clientId, out id);
if ((OP_STATUS)returnVal == OP_STATUS.SUCCESS)
{
    return id;
}
else
    return CommandFailed(returnVal);
```

Comments

The dutId is an OUT parameter whose value is set after the server processes the request.

ChangeDutId()

ChangeDutId(*string* id, *string* dutName)

This method changes the DUT id of the set-up. The client has to provide a valid DUT id.

Parameters

Name	Type	Direction	Description
id	string	IN	Identifier of the client that is performing the remote funtion.
dutName	string	IN	The new DUT id of the set-up.

Return Value

String that suggests the status of the operation after it has been performed.

Example

```
If (dut Id.Length <=0 && locked == true)
    return "Enter a valid DUT-ID";
returnVal = remoteObject.ChangeDutId(clientId, dutId);
if ((OP_STATUS)returnVal == OP_STATUS.SUCCESS)
    return "DUT Id Changed...";
else
    return CommandFailed(returnVal);
```

Comments

If the dutName parameter is null, the client is prompted to provide a valid DUT id.

SaveSession()

SaveSession(*string* id, *string* name)

Saves the current session. The name of the session is provided by the client.

Parameters

Name	Type	Direction	Description
id	string	IN	Identifier of the client that is performing the remote funtion.
name	string	IN	The name of the session being saved.

Return Value

String that suggests the status of the operation after it has been performed.

Example

```
returnVal = remoteObject.SaveSession(clientId,sessionName);  
if ((OP_STATUS)returnVal == OP_STATUS.SUCCESS)  
    return "Session Saved...";  
else  
    return CommandFailed(returnVal);
```

Comments

The name parameter cannot be empty. If it is empty, the client is prompted to provide a valid name.

Once the session is saved under 'name' you cannot use this method to save the session in a different name. Instead SaveSessionAs can be used.

SaveSessionAs()

SaveSessionAs(*string* id, *string* name)

Saves the current session in a different name every time this method is called. The name of the session is provided by the client.

Parameters

Name	Type	Direction	Description
id	string	IN	Identifier of the client that is performing the remote funtion.
name	string	IN	The name of the session being saved.

Return Value

String that suggests the status of the operation after it has been performed.

Example

```
returnVal = remoteObject.SaveSessionAs(clientId,sessionName);  
if ((OP_STATUS)returnVal == OP_STATUS.SUCCESS)  
    return "Session Saved...";  
else  
    return CommandFailed(returnVal);
```

Comments

The same session is saved under different names using this method. The name parameter cannot be empty. If it is empty, the client is prompted to provide a valid name.

RecallSession()

RecallSession(*string* id, *string* name)

Recalls a saved session. The name of the session is provided by the client.

Parameters

Name	Type	Direction	Description
id	string	IN	Identifier of the client that is performing the remote function.
name	string	IN	The name of the session being recalled.

Return Value

String that suggests the status of the operation after it has been performed.

Example

```
returnVal = remoteObject.RecallSession(clientId,sessionName);  
if ((OP_STATUS)returnVal == OP_STATUS.SUCCESS)  
    return "Session Recalled...";  
else  
    return CommandFailed(returnVal);
```

Comments

The name parameter cannot be empty. If it is empty, the client is prompted to provide a valid name.

Run()

Run(*string* id)

Runs the setup. Once the server is set up and is configured, it can be run remotely using this function.

Parameters

Name	Type	Direction	Description
id	string	IN	Identifier of the client that is performing the remote function.

Return Value

String that suggests the status of the operation after it has been performed.

Example

```
returnVal = remoteObject.Run(clientId);  
if ((OP_STATUS)returnVal == OP_STATUS.SUCCESS)  
    return "Run started...";  
else  
    return CommandFailed(returnVal);
```

Comments

When the run is performed the status of the run is updated periodically using a timer.

Stop()

Stop(*string* id)

Stops the run operation.

Parameters

Name	Type	Direction	Description
id	string	IN	Identifier of the client that is performing the remote funtion.

Return Value

String that suggests the status of the operation after it has been performed.

Example

```
returnVal = remoteObject.Stop(clientId);  
if ((OP_STATUS)returnVal == OP_STATUS.SUCCESS)  
    return "Stopped...";  
else  
    return CommandFailed(returnVal);
```

Comments

When the session is stopped the client is prompted to stop the session and is stopped at the consent.

QueryStatus()

QueryStatus(*string* id, *out string[]* status)

This method gives the status of the run as messages. The status messages are generated once the run is started.

Parameters

Name	Type	Direction	Description
id	string	IN	Identifier of the client that is performing the remote funtion.
status	string array	OUT	The list of status messages generated during run.

Return Value

String that suggests the status of the operation after it has been performed.

Example

```
returnVal = remoteObject.QueryStatus(clientId, out statusMessages);  
if ((OP_STATUS)returnVal == OP_STATUS.SUCCESS)  
    return "Status updated...";  
else  
    return CommandFailed(returnVal);
```

Comments

The status messages are updated periodically after the run begins. The status is an out parameter which is set when the server processes the request.

TransferReport()

TransferReport(*string* id, *string* filePath)

This method transfers the report generated after the run. The report contains the summary of the run. The client has to provide the location where the report is to be saved at the client-end.

Parameters

Name	Type	Direction	Description
id	string	IN	Identifier of the client that is performing the remote function.
filePath	string	IN	The location where the report has to be saved in the client.

Return Value

String that suggests the status of the operation after it has been performed.

Example

```
returnVal = remoteObject.TransferReport(clientId);  
if ((OP_STATUS)returnVal == OP_STATUS.SUCCESS)  
    return "Transferred...";  
else  
    return CommandFailed(returnVal);
```

Comments

If the client does not provide the location to save the report, the report is saved at C:\ProgramFiles.

CheckSessionSaved()

CheckSessionSaved(*string* id, *out bool* saved)

This function is called when a check is to be made to know if the current session is saved.

Parameters

Name	Type	Direction	Description
id	string	IN	Identifier of the client that is performing the remote function.
saved	bool	OUT	Boolean which represents if the current session is saved.

Return Value

Void

Example

```
if (clientId == ClientID)
{
    returnVal = remoteObject.IsSessionSaved(id,out saved);
}
```

Comments

The saved parameter gives the boolean value suggesting if the current session is saved or not. This is used as a check in SaveSession() and SaveSessionAs() Functions.

ApplicationStatus()

ApplicationStatus(string id)

This method gets the status (ready, running, paused) of the server application.

Parameters

Name	Type	Direction	Description
Id	string	IN	Identifier of the client that is performing the remote function.

Return Value

String value that gives the status of the server application.

Example

```
returnVal = remoteObject.ApplicationStatus(clientId);  
return returnVal;
```

Comments

The application can be in one of the following states at a given time:

- Ready – Test configured and ready to start
- Running – Test running
- Paused – Test paused

ErrorCodes

The return value of the remote automations at the server-end is OP_STATUS which is changed to a string value depending on its code and returned to the client.

The values of OP_STATUS are as follows:

Value	Code	Description
FAIL	-1	The operation failed.
SUCCESS	1	The operation succeeded.
NOTFOUND	2	Server not found
LOCKED	3	The server is locked by another client, so operation cannot be performed.
UNLOCK	4	The server is not locked. Lock the server before performing the operation.
NULL	0	Nothing

Example

The following is an example for NI TestStand Client available in the path, C:\Program Files\Tektronix\TekExpress\Examples\Programmatic Interface\TestStand

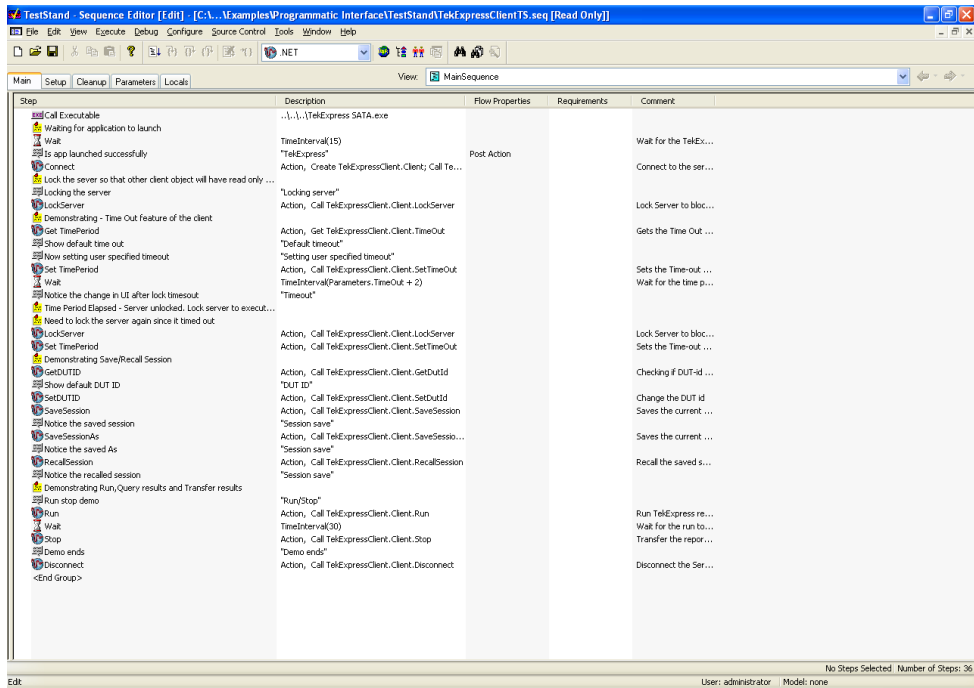

Instrument Connectivity

Related Topics

[User Interface](#)

[TestStand Runtime Engine Installation](#)

If the instrument(s) are displayed in TekVISA Instrument Manager but not in the TekExpress Instrument Bench, check the following:

- Only those instruments that respond to *i dn? and *opt? queries successfully, are displayed in Instrument Bench.
- Ensure that VXI-11 Server is running on the instruments.

If Instrument initialization fails during test sequence execution, do the following:

It is observed that GPIB communication with instrument over Tek-VISA layer is not initialized if in TekVISA Instrument manager the search criteria is turned-off even if valid instrument is connected in the network. It is necessary to turn ON the respective search criteria by opening the TekVISA Instrument manager.

User Interface

Related Topics

[Instrument Connectivity](#)

[TestStand Runtime Engine Installation](#)

The Acquire tab is disabled.

For a selected test suite, the test is performed on a live acquisition. If test(s) such as PHY-TSG-OOB can be performed on pre-acquired waveforms, this tab is active.

TestStand Run time Engine Installation

Related Topics
[Instrument Connectivity](#)
[User Interface](#)

Managing multiple versions of TestStand installed on the system.

TekExpress installs TestStand version 3.5 runtime engine. If you have versions other than 3.5, while working with TekExpress, ensure that the version shipped with TekExpress is active. You can do so by clicking **Start > Programs > National Instruments > TestStand 3.5 > TestStand Version Selector**.

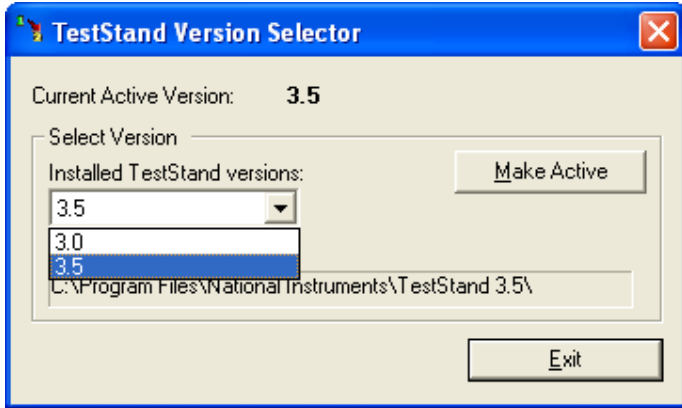

Test Limit is Single Sided

Related Topics

[Instrument Connectivity](#)

[TestStand Runtime Engine Installation](#)

[User Interface](#)

The test limit is single sided but report shows second value and value is shown as 0.

If the test limits are single sided for limits such as GT(>) Greater than, LT(<) Less than; then the second value is by default 0 and is ignored by test automation script. In such cases, while analyzing the report the second value should be ignored.

Report shows as NAN

Related Topics

[Instrument Connectivity](#)

[TestStand Runtime Engine Installation](#)

[User Interface](#)

[Test Limit is Single Sided](#)

Some of the result values in the report are shown as NAN.

NAN is IEEE definition for “Not a Number”. The possible causes are as follows:

- The captured pattern (HFTP, MFTP, LFTP, LBP waveform files) for the analysis does not contain a valid pattern.
- The NAN value is commonly seen in TSG measurements when LFTP pattern is required for analysis but the captured pattern is not true LFTP.
- The NAN value can be seen in the final reports if a test algorithm does not successfully evaluate a result due to one or more reasons listed above.

For trouble shooting, you can analyze the captured waveform using pattern analyzer utility which is available in TekExpress\ACP folder. The `patternAnalyzer.exe` need to be run from MS DOS prompt and takes the following command line argument:

```
patternAnalyzer.exe <InterfaceSpeed> <WaveformFile> <OutputTXTfile> where,
```

InterfaceSpeed should be specified as either Gen1 or Gen2.

waveform file is complete waveform file path.

outputTXTfile is output text file path.

For example, `patternAnalyzer.exe "Gen2" "X:\Serial ATA\SavedSession\DUT001\20080206_185914\BISTL_HFTP_G2_Drive_DW2_Diff.wfm" "X:\results.txt"`.
Open the contents of `X:\results.txt` to see the results.

Instrument Connectivity using GPIB Cable

The following schematic illustrates the GPIB connectivity of instruments when TekExpress is running on a stand-alone computer.

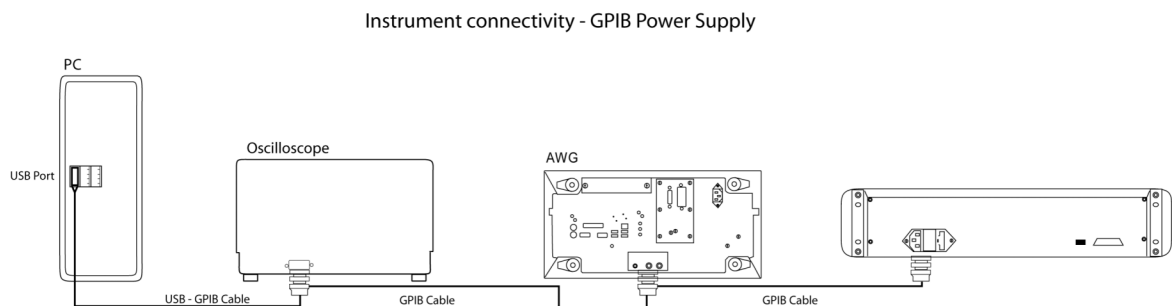

The following schematic illustrates the GPIB connectivity of instrument when TekExpress is running on an oscilloscope.

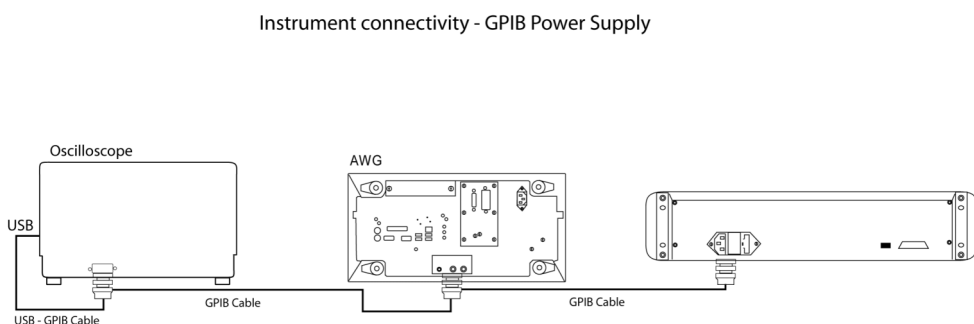

Shortcut Keys

The following table lists the short cut keys to access the application:

Table 10: Keyboard shortcut keys

Menu	Shortcut keys
File	Alt + F
New Session	Ctrl + N
Open Session...	Ctrl + O
Save Session...	Ctrl + S
Save Session As	Alt + F + A
Save Report As...	Alt + F + R

Table 10: Keyboard shortcut keys (cont.)

Menu	Shortcut keys
Print Preview Report	Alt + F + V
Print Report...	Ctrl + P
Recent Sessions	Alt + F + E
Exit	Ctrl + X
View	Alt + V
Log File	Ctrl + L
Tools	Alt + T
Instrument Bench...	Ctrl + I
Debug-Deskew Utility	Alt + T + D
Help	Alt + H
TekExpress Help (F1)	Alt + H + H
About...	Alt + H + A

Error Codes for TekExpress

The following table lists the error codes for the application. Most of the errors require that you restart the system.

Table 11: Error codes and description

Error Code	Description
<10000	TestStand generated error.
10001 - 11000 – Data Manager related errors	
10001	Insufficient Data. The Record could not be inserted. The following fields are empty or have insufficient data.
10002	Could not retrieve the record. The specified index is not valid.
11001 - 14000 – ICP related errors	
11001	Operation mode is not set as specified.
11002	SetUp file Error: Specified SetUp file is not set.
11003	Operation state is not set as specified.
11004	Specified waveform is not loaded into channel memory.
11005	Specified channel is not enabled.
11006	Interleave State could not be set to off.
11007	AWG Memory Import Error. Could not import the specified waveform into AWG memory. Filename not found.
11008	AWG Waveform Editing Error: Could not insert the specified pattern into the AWG sequence.
12001	Operation State is not set to required value.
12002	Display state is not set to required value.
12003	Horizontal Scale is not set to required value.
12004	Vertical scale is not set to required value.
12005	Vertical Position is not set to required value.
12006	Deskew is not set to specified value.
12007	Out of Range Error-RunTime Error Message.
13001	Acquisition timed out
13002	Channel deskew failed
13003	"Recall setup failed. Setup file not present in the specified location <File Path>
13004	Recall setup Failed - OperationTimed out
13005	Suspecting module failure\nFollowing channels does not have the required Peak-To-Peak value when TDR is generated\
13006	Please swap Module 1 with Module <N>
14001 - 18000 – SCP related errors	
14001	Timeout Error: Application could not be activated.

Table 11: Error codes and description (cont.)

Error Code	Description
14002	JIT3 Application is already running.
14003	Cannot activate JIT3 application. Some other application is running on oscilloscope.
14004	Error recalling the specified setup.
14005	Error setting the specified Sequencer State.
14006	Error in closing the Application.
14007	Error loading the default setup.
15001 – 15006 – Iconnect Errors	
15001	Z-Line function failed\nOutput file not created
15002	S-Parameter function failed\nOutput file not created
15003	Eye measurement function failed\nOutput file not created
15004	Filter function failed\nOutput file not created
15005	IConnect not installed
15006	Input waveform not present in the specified location
20001 – 25000 — Framework related codes	
20001	Code for UI message passed from TestStand to Framework
20002	Code for UI message passed from TestStand to Framework
20003	Code for UI message passed from TestStand to Framework
20004	Code for UI message passed from TestStand to Framework
20005	Code for displaying dialog box passed from TestStand to Framework
20006	Code for displaying input box passed from TestStand to Framework
20007	Code for calling exception handler passed from TestStand to Framework
20008	Code for calling image box passed from TestStand to Framework
20009	Code for getting the pass/fail status in the analyze panel passed from TestStand to Framework
20010	Code for getting the prerecorded waveforms path passed from TestStand to Framework
20011	Code for displaying input dialog box passed from TestStand to Framework
20012	Code for getting the foot note passed from TestStand to Framework
25001 - 27000 - Other Errors	
25001	Analyze operation failed\n\nIConnect could not process the input waveforms or\nIt generates output waveforms that cannot be processed futher\nCheck your configuration parameters
25002	LabVIEW Adapter configuration failed

Index

A

- About menu, 24
- About TekExpress, 15
- Acquire parameters, 33
 - Automatically option, 107
 - Manually option, 109
 - supported oscilloscopes, 107
- Acquire Parameters, 29
- Acquire source options, 33
- Activating License, 10
- Amplitude Calibration, 116
- Analyze Parameters, 29
- Application Summary, 15
- Applying RF switch state, 23
- Attenuation values, 23
- AWG Calibration, 138

B

- Batch file, 113
- Batch file usage, 113
- Before clicking Run, 12

C

- Calibration Procedure, 133
- Calibration process, 111
- Client, 141
- Compliance mode, 28
- Configure button, 26
- Controlling the Server, 142

D

- Data Storage, 40
- Debug deskew utility, 22
- Default Directory Usage, 8
- Deskew, 22
 - Real Time Oscilloscopes, 99
 - Sampling Oscilloscopes, 100
- Deskew values, 23
- Directory Structure, 8
- dongle, 16
- DUT power cycle operation, 119

E

- Equipment Setup
 - Cable SI, 94
 - Drive PHY-TSG-OOB, 58
 - Drive RSG-RMT, 41
 - Drive RxTx, 80
 - Host RSG-RMT, 49
 - Host RxTx, 89
 - SI, 94
- Error Codes, 173
- Exiting the Application, 17

F

- Features, 5
- File Name Extensions, 9
- Frame Error Analyzer, 6

G

- General parameters, 28
- Generating jittered
 - waveforms, 114
- Global Controls, 18
- GPIO Cable, 171

I

- Inputs to Pattern Generation
 - Utility Ver 2.0, 111
- Instrument Bench, 21
- Instrument Bench menu, 31
- Instrument Connectivity, 171
- Instrument discovery, 31
- Instrument initialization, 167
- Interface, 141

Interface commands

- ChangeDutId, 154
- Connect, 146
- Disconnect, 147
- GetDutId, 153
- GetTimeOut, 152
- LockSession, 148
- RecallSession, 157
- Run, 158
- SaveSession, 155
- SaveSessionAs, 156
- SetTimeOut, 150
- Status, 160
- Stop, 159
- TransferReport, 161
- UnlockSession, 149
- Interface error codes, 164
- ISI Jitter characterization, 111

J

- Jitter Measurement Devices, 123
- Jitter related measurements, 114
- jitter source, 123
- Jitter Transfer Function, 123
- Jitter Transfer Function
 - calibration, 123
- JTF attenuation, 123
- JTF bandwidth, 123

K

- Keithley Switch, 6
- Key Features, 15

L

- Log File, 20

M

- Manual Power Cycle, 119
- Mapping My TekExpress
 - folder, 12
- Match samplers, 101
- Match TDR pulses, 103

math waveform, 139

Menus

- File, 19
- Help, 24
- Tools, 21
- View, 20

MODE measurement, 139

My TekExpress, 40

My TekExpress folder, 12

N

Naming convention

- SI test suite waveforms, 35

Naming Convention

- RXTX test suite waveforms, 34

NAN, 170

Non VISA resources, 22

O

OOB01 Calibration, 138

Overriding Acquire parameters, 107

Overview, 15

P

Parameters to configure, 28

Pattern Generation Utility, 111

Pattern Generation Utility Ver 2.0, 111

Power Cycle using AWG DC output, 119

Power Splitter, 6

Prerecorded waveform files, 33

Programmatic Interface, 141

Progress of Analysis, 37

Proxy Object

- Client, 143
- Remote, 143

R

Random Jitter Calibration, 115

Reactivating License, 10

Reading Attenuation values, 23

Reading Deskew values, 23

Recent Sessions, 19

Record Length, 109

Reference waveforms, 34

Related Documentation, 2

Report

- NAN, 170

Report panel overview, 39

residual jitter, 123

Resizing the Application, 17

Resolution, 109

Restoring Deskew values, 23

Retrieved Instruments, 22

RF switch state, 23

RMT test on drive, 46

RMT test on host, 55

RSG test on SATA drive, 43

RSG02 test on host, 51

Run

- Run button, 18

Run button, 18

S

Safety Summary, v

SATA devices, 25

Save

- Report, 19
- Session, 19

Select panel, 25

Selecting acquisition source, 33

Selecting Connected Instruments, 32

Server, 141

Session folder, 40

Setting User Configuration, 119

Shortcut Keys, 171

Show Acquire Parameters, 33

Show MOI button, 26

Show Schematic button, 26

Signal Path Compensation (SPC), 99

Single Sided, 169

SMA Barrel Adapters, 100

Software version, 24

SSC, 123

Starting the Application, 16

System Requirements, 7

T

TDR pulses, 103

TDS Oscilloscope, 138

Technical Support, 3

TekVISA Instrument Manager, 31

Test Fixture, 6

Test Limit

- Single Sided, 169

Test Limits, 30

Test Parameters, 29

Test Related Files, 40

Test Suite, 26

Test suite waveforms, 34

Test(s)

- Configure, 28
- Report, 39
- Select, 25

TestStand Client example, 165

TestStand sequence, 119

Time Interval Error (TIE), 124

Tj Calibration, 116

Transition Time Validation, 118

TroubleShooting

- Instrument Connectivity, 167
- TestStand Run-time Engine Installation, 168
- User Interface, 167

U

Untitled Sesssion, 12

USB dongle, 16

Use of prerecorded waveform for analysis, 33

User defined mode, 28
using DPOJET, 133

V

View Scorecard, 39

Viewing Connected Instruments, 31

W

Waveform File, 33

without DPOJET, 138